

SY325

WOOD/PELLET BOILER

COMBI 3

Summary

| | | |
|--------------------------------------|-----------------------------------|-----------|
| 1 | INSTALLATION..... | 3 |
| 2 | CONFIGURABLE INPUTS..... | 6 |
| 3 | DIGITAL INPUTS | 7 |
| 3.1 | SAFETY THERMOSTAT INPUT..... | 7 |
| 3.2 | PELLET THERMOSTAT..... | 7 |
| 3.3 | PRESSURE SWITCH..... | 7 |
| 3.4 | CHRONO INPUT | 7 |
| 3.5 | DOOR INPUT | 8 |
| 3.6 | AMBIENT THERMOSTAT INPUT..... | 8 |
| 3.7 | PELLET LEVEL SENSOR | 8 |
| 3.8 | FLOWSWITCH | 9 |
| 3.9 | GRID SENSOR..... | 9 |
| 4 | ANALOGICAL INPUTS..... | 9 |
| 5 | CONTROL BOARD..... | 10 |
| 5.1 | BUTTONS | 10 |
| 5.2 | LED | 11 |
| 5.3 | DISPLAY | 11 |
| 6 | MENU | 12 |
| 6.1 | USER MENU..... | 12 |
| 6.2 | PROTECTED MENU | 13 |
| 6.3 | NOT PROGRAMMABLE PARAMETERS | 21 |
| 7 | FUNCTIONING STATES | 22 |
| 7.1 | FUNCTIONING CONFIGURATION | 23 |
| PELLET FUNCTIONING..... | | 24 |
| 7.1.1 | OFF..... | 24 |
| 7.1.2 | Check Up..... | 24 |
| 7.1.3 | Ignition..... | 24 |
| 7.1.4 | Stabilization..... | 26 |
| 7.1.5 | Recover Ignition | 26 |
| 7.1.6 | Normal..... | 26 |
| 7.1.7 | Modulation | 27 |
| 7.1.8 | Standby | 27 |
| 7.1.9 | Safety..... | 28 |
| 7.1.10 | Extinguishing..... | 28 |
| 7.2 WOOD FUNCTIONING | | 29 |
| 7.2.1 | OFF..... | 29 |
| 7.2.2 | Ignition..... | 29 |
| 7.2.3 | Stabilization..... | 30 |
| 7.2.4 | Recover Ignition | 30 |
| 7.2.5 | Normal..... | 30 |
| 7.2.6 | Modulation | 31 |
| 7.2.7 | Standby | 31 |
| 7.2.8 | Safety..... | 32 |
| 7.2.9 | Extinguishing..... | 32 |
| 7.3 FUNCTIONING COMBI 1 | | 33 |



| | | |
|------------|--|-----------|
| 7.3.1 | OFF | 33 |
| 7.3.2 | Functioning System with Wood..... | 33 |
| 7.3.3 | System Functioning with Pellet | 33 |
| 7.3.4 | Recover Ignition | 33 |
| 7.4 | FUNCTIONING COMBI 2 | 34 |
| 7.4.1 | OFF | 34 |
| 7.4.2 | System Ignition by Pellet..... | 34 |
| 7.4.3 | Wood ignition | 34 |
| 7.4.4 | Recover Ignition | 35 |
| 7.4.5 | WOOD Functioning | 35 |
| 7.4.6 | PELLET FUNCTIONING..... | 35 |
| 8 | ADDITIONAL FUNCTIONS | 36 |
| 8.1 | PUMBLING CONFIGURATION MANAGEMENT | 36 |
| 8.1.1 | Plant 0..... | 36 |
| 8.1.2 | Plant 1..... | 37 |
| 8.1.3 | Plant 2..... | 38 |
| 8.1.4 | Plant 3..... | 39 |
| 8.1.5 | Plant 4..... | 40 |
| 8.1.6 | Plant 5..... | 41 |
| 8.1.7 | Plant 6..... | 42 |
| 8.2 | SYSTEM'S FUNCTIONING MODALITY..... | 43 |
| 8.3 | CONFIGURABLE OUTPUTS MANAGEMENT..... | 43 |
| 8.3.1 | Safety Valve | 44 |
| 8.3.2 | Pellet Loading Engine..... | 44 |
| 8.3.3 | Cleaning engine..... | 44 |
| 8.3.4 | Combustion Fan 2..... | 44 |
| 8.3.5 | AIR Valve..... | 44 |
| 8.3.6 | Auger with Relay | 44 |
| 8.3.7 | Inverter Consent..... | 45 |
| 8.3.8 | Error Warning..... | 45 |
| 8.3.9 | Auger 2 Pause Work | 45 |
| 8.3.10 | Auger 2 always on | 45 |
| 8.3.11 | Safety Valve 2 | 45 |
| 8.4 | AUGER WITH WOOD PROGRESS..... | 45 |
| 8.5 | INVERTER MANAGEMENT | 45 |
| 8.6 | MODEM GSM MANAGEMENT | 46 |
| 8.6.1 | Basic Function | 47 |
| 8.6.2 | Advanced Function | 47 |
| 8.7 | COMMUNICATION RS232 | 48 |
| 8.8 | FIRMWARE UPDATE | 48 |
| 8.9 | DIAGNOSTIC FUNCTION..... | 48 |

1 INSTALLATION

THE CONNECTOR AND THE CONNECTIONS

In the following image there is the connection model of the main board connectors and the related inputs and outputs. Then the connection modalities of the inputs and outputs and the instructions to follow for a correct installation.

WARNINGS:

-  **Always connect earth cable.**
-  **Follow carefully the connection described in order to avoid damages**
-  **Low voltage signals (Probes, Digital inputs, etc) should be separated from High voltage Signals (Power Supply, Outputs, etc.) in order to reduce the interferences.**

ELECTRIC CONNECTION DIAGRAM

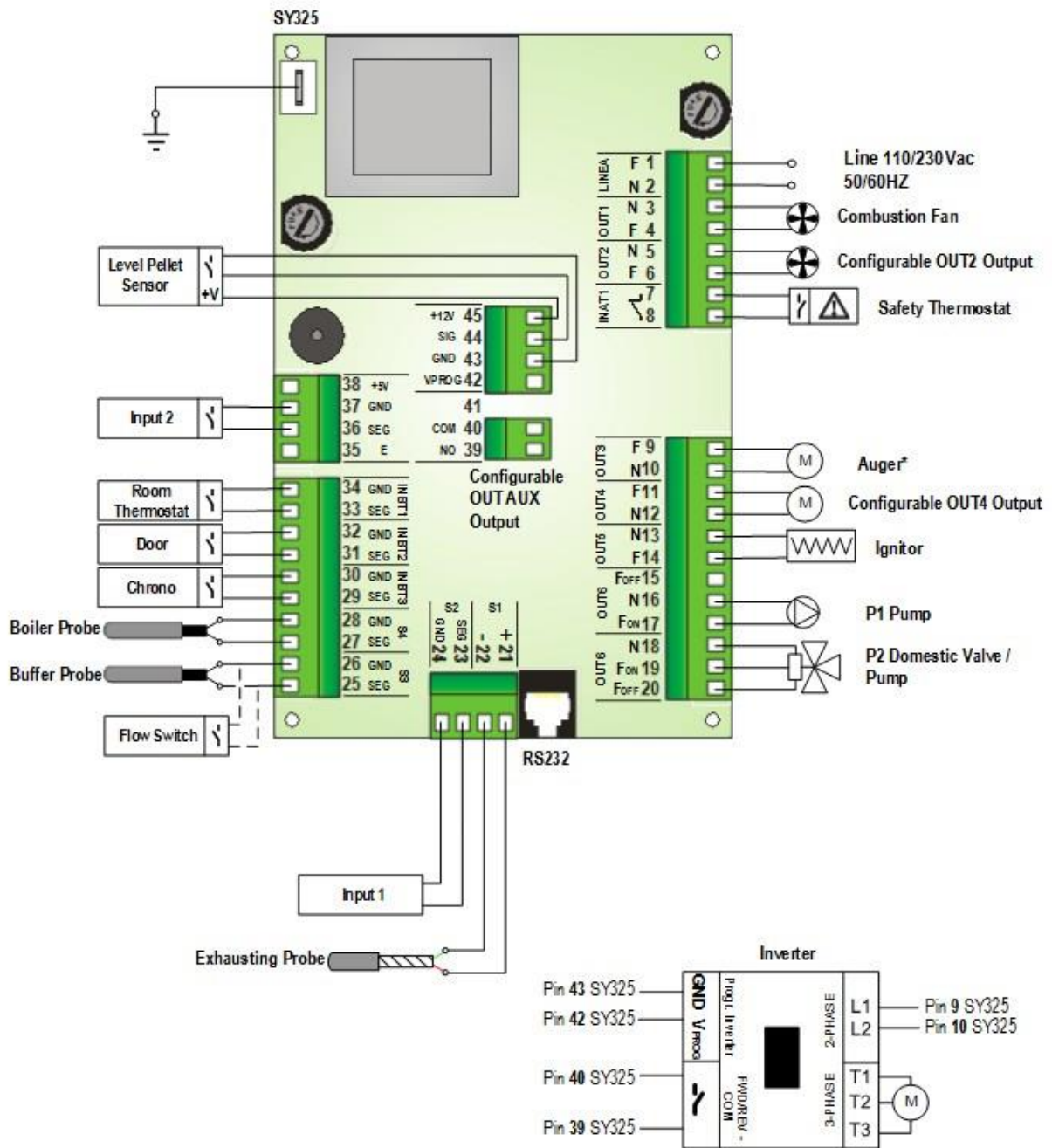

| Pin | Function | Technical Characteristics |
|---|--|--|
| 1-2 | Line | Version 230Vac \pm 10% 50/60 Hz Version 110Vac \pm 10% 50/60 Hz Fuse T6,3A |
| 3-4 | Combustion Fan | Triac Regulation. Supplied Max 1.3 A |
| 5-6 | Configurable Output OUT2: See Par. 8.3 | Triac Regulation. Supplied Max 1.3 A |
| 7-8 | Input for Safety Thermostat (AT1). See Par. 3.1 | High tension Input. Contact open/closed |
| 9-10 | Auger | Triac Regulation. Supplied Max 1.3 A |
| 11-12 | Configurable Output OUT4: See Par. 8.3 | ON/OFF Relay. Supplied Max 3 A |
| 13-14 | Auger | ON/OFF Relay. Supplied Max 3 A |
| 15-16-17 | P1 Pump | ON/OFF Relay. Supplied Max 3 A 15 F _{OFF} 16 N 17 F _{ON} |
| 18-19-20 | P2 Domestic valve / Pump | ON/OFF Relay. Supplied Max 3 A 18 N 19 F _{ON} 20 F _{OFF} |
| 21-22 | Exhaust probe | Thermo couple See Ch. 3 21: Red (+) 22: Green (-) |
| 23-24 | Input 1 Grid Contact: See Ch. 3.9 Photoresistance: See Ch. 4 Pellet Thermostat: See 3.2 | Contact open/closed Analogical input |
| 25-26 | Puffer probe / Boiler: See Ch. 4 or Flowswitch: See Par. 3.8 | Analogical Input 25: Signal 26: GND 38: +5V (feed Flowswitch if necessary) |
| 27-28 | Boiler probe: See Ch. 4 | Analogical Input |
| 29-30 | External Chrono Input: See Par. 3.4 | Contact open/closed |
| 31-32 | Door Input: See Par. 3.5 | Contact open/closed |
| 33-34 | Input Ambient thermostat: See Par. 3.6 | Contact open/closed |
| 36-37 | Input 2 Input Air Pressure Switch: See Par. 3.3 Pellet Thermostat: See 3.2 | Contact open/closed |
| 39-40 | Configurable Output OUT AUX: See Par. 8.3 | Contact ON/OFF Relay. Not Supplied Max 1 A |
| 42-43 | DAC Output for Inverter programming | Available Voltage signal: 0÷10VDC 42 V _{PROG} 43 GND |
| 43-44-45 | Pellet level Sensor Input See Par. 3.7 | 43 GND 44 Signal 45+12V |
| RS232 | Serial connection to PC / USB_Programmer | Serial port RS232 |
|  | Connection to earth Plant Always connected | |

Note:

To have a correct functioning of the Triac outputs, always connect a minimum load of 20 W. Otherwise, if the output is activated, the Triac is not able to turn off.

2 CONFIGURABLE INPUTS

The board has two configurable inputs: Input 1 (**Pin 23-24**) through parameter **P27** and Input 2 (**Pin 36-37**) through parameter **P91**.

Input 1:

| P27 | <i>Tipologia Ingresso</i> |
|------------|---------------------------|
| 0 | Not Used |
| 1 | Grid Sensor (3.9) |
| 2 | Photoresistance* |
| 3 | Photoresistance* |
| 4 | Pellet Thermostat (3.2) |

* The combustion sensor is Thermo couple only if **P27** = 0,1,4; Photoresistance only if **P27** = 2; Thermo couple and Photoresistance if **P27** = 3.

Input 2:

| P91 | <i>Tipologia Ingresso</i> |
|------------|---------------------------|
| 0 | Not Used |
| 1 | Pressure Switch (3.3) |
| 2 | Pellet Thermostat (3.2) |

3 DIGITAL INPUTS

3.1 SAFETY THERMOSTAT INPUT

The opening of the contact of the **Manual Rearmed Thermostat** in any functioning state, stops the Auger and Fans' functioning, activates the Pump and starts the state **EXTINGUISHING**.

On the Control board appears the error of intervention of the Thermostat **Alt tSic**.

- If the system has not the use of a Rearmed thermostat **short circuit Pin 7-8** of the connector

3.2 PELLET THERMOSTAT

The Pellet Thermostat use one of the two configurable inputs: Input 1 (**Pin 23-24**) with **P27** = 4 or Input 2 (**Pin 36-37**) with **P91** = 2.

When the contact is open there is backfire: the timer **t38** starts, if the contact is not closed within this time the system goes to **EXTINGUISHING** and the display shows the error message **Alt tPEL**.

The behavior at the opening of the contact is this:

- If **P59** or **P60** are 16 or 17 (product with two Augers): the Auger stops, the Auger2 is always on
- If **P59** or **P60** are 1 (product with Auger and Safety Valve): the Auger stops and the Safety Valve closes
- If **P59** or **P60** are 28 (product with Auger and Safety Valve 2): the Auger is on at the dedicated power (parameters **CL81-CP81-CU81**)
- If **P59** or **P60** are 1 and 16 or 17 (product with two Augers and Safety Valve): the Auger stops, the Safety Valve closes and the Auger2 is always on
- If **P59** or **P60** are 16 or 17 and 28 (product with two Augers and Safety Valve 2): the Auger is on at the dedicated power (parameters **CL81-CP81-CU81**), the Safety Valve opens and the Auger2 is always on
- If **P59** or **P60** are different from 1, 16, 17 and 28 (product with an Auger): the Auger is on at the dedicated power (parameters **CL81-CP81-CU81**)
- The Combustion Fan is on at the dedicated power **Uc81** while the Combustion Fan 2, if present, is on at the power **UA81**

About parameters **P59** and **P60** see 8.3.

3.3 PRESSURE SWITCH

For the Pressure Switch use the configurable Input 2 (**pin 36-37**) with parameter **P91** = 1.

The Contact is normally opened. With Combustion Fan on, the Contact opening starts a timer of **t15** seconds, after that the system starts **EXTINGUISHING**.

On the Control Board appears the error **Alt PrES**.

- If the system has not the use of a Pressure Switch **short circuit Pin 36-37** of the connector.

3.4 CHRONO INPUT

The board has a Contact in the connector **pin 29-30**, for the use of a module External Clock. The functioning of this Input can be programmed from the Secret menu with the parameter **P03**.

1. **P03 = 0 (deactivated in only Wood functioning)**

Opening Contact External chrono:

- The system if functioning at **Pellet** or **Wood+Pellet** starts the state **EXTINGUISHING**

Closing Contact External chrono:

- The system if functioning at **Pellet** or **Wood+Pellet** starts the state **CHECK UP**

The Contact must be normally open.

2. **P03 = 1 (active in all functioning)**

Opening Contact External chrono:

- The system if functioning at **Wood** or **Pellet** not in **Ignition** and **Stabilization** starts the **STANDBY**

Closing Contact External chrono:

- The system if functioning at **Wood** or **Pellet** starts the state **IGNITION**

The Contact must be normally closed.

- If the system has not the use of a module Chrono **Short circuit Pin 29-30** of the connector in case of **P03 = 1** otherwise leave them free.

3.5 DOOR INPUT

The board has a Contact in the connector **pin 31-32**, to be used as door limit switch of the boiler. The contact must be normally closed. The functioning of this Input can be programmed from the Secret menu with the parameter **P15** for the Combustion fan 2 and **P73** for the Combustion fan.

Opening Contact DOOR:

| Display Visualization | Parameter | Combustion Fan | Combustion Fan 2* | Auger | Igniter |
|-----------------------|----------------|------------------------|------------------------|-------|---------|
| Port | P15 = 0 | - | OFF | OFF | OFF |
| Port | P15 = 1 | - | Max Speed (99%) | OFF | OFF |
| Port | P73 = 0 | OFF | - | OFF | OFF |
| Port | P73 = 1 | Max Speed (99%) | - | OFF | OFF |

This configuration is activated in all the functioning States of the controller except **OFF**. In this state if the functioning is **Wood** or **Pellet**, the Combustion Fan and the Combustion Fan2 (if ON in the configurable outputs) will be activated only if Exhaust Temperature will be over **F00** and **F16** thermostats.

This functioning guarantees a combustion fall in case of Door Opening with the boiler on.

- If the system has'n got a Door limit switch **short circuit Pin 31-32** of the connector.

3.6 AMBIENT THERMOSTAT INPUT

The board has a Contact in the connector **pin 33-34**, for the use of a module External Ambient thermostat. The functioning of this Input can be programmed for the Secret Menu with the parameter **P04**.

1. **P04 = 0 (Activated for all functioning)**

Opening Contact Ambient thermostat:

- Pump **OFF**

Closing Contact Ambient thermostat:

- Pump **ON over Thermostat Pump A01**

This Function is not active in case of alarm for **Water Safety**, **Anti freezing** and **Rearmed thermostat**.

The Contact in this case must be normally closed.

2. **P04 = 1 (Activated for all functioning)**

Opening Contact Ambient thermostat:

- The system if functioning at **Wood** or **Pellet** not in **Ignition** and **Stabilization** starts the state **STANDBY**

Closing Contact Ambient thermostat:

- The system if functioning at **Wood** or **Pellet** starts the state **IGNITION**

The Contact in this case must be normally closed.

3. **P04 = 2 (deactivated in functioning only Wood)**

Opening Contact Ambient thermostat:

- The system if functioning at **Pellet** or **Wood+Pellet** starts the state **EXTINGUISHING**

Closing Contact Ambient thermostat:

- The system if functioning at **Pellet** or **Wood+Pellet** starts the state **CHECK UP**

The Contact in this case must be normally open.

- If the system has not the use of a module Ambient thermostat **Short circuit Pin 33-34** of the connector in case of **P04 = 0 or 1** otherwise leave them free.

3.7 PELLET LEVEL SENSOR

The board has a Contact in the connector **pin 43-44-45**, for the use of a sensor to detect the minimum level of the combustible in the Silos.

The management of the sensor varies according to its type:

- **Pellet Level Sensor with free contact output:**
Connect the Contact's wires to **pin 45 (+12V)** and **44 (Signal)**.
If the contact is Normally closed, set the parameter **P54 = 1**.
If the contact is Normally open, set the parameter **P54 = 2**.
If not used, set the parameter **P54 a 0**.
- **Pellet Level Sensor with continuous tension output:**
Connect the positive supply line wire to **pin 45 (+12V)**
Connect the ground wire to **pin 43 (GND)**
Connect the output wire to **pin 44 (Signal)**
If with material the output is at a high level (5V or 12V), set the parameter **P54 a 1**.
If with material the output is at a low level (0V), set the parameter **P54 a 2**.
If not used, set the parameter **P54 a 0**.

Note:

If any configurable output is set as Pellet Load Engine, when the system is in Pellet functioning and the sensor reads no material in the tank, on display appears **Pell** and after the time **t55** the System starts **EXTINGUISHING** with error message **Alt Pell**.

3.8 FLOWSWITCH

At pin **25-26-38** is available an Input Flowswitch if present in the Hydraulic plant (See par 8.1)

At pin 38 of the Control Board is available a tension of +5V if the Flowswitch is supplied.

If not used leave the pin of the connector open.

3.9 GRID SENSOR

At pin 23-24 (only if **P27 = 1**) is available an Input for the connection of a Contact to detect the presence of Wood on the brazier/grid.

If the Contact is closed and the functioning is Pellet, on the display appears **Grid**; if the system is OFF, Ignition is not possible until the Contact opens.

If the functioning is Combined, when passing the Pellet, if the Contact is closed, the system starts OFF with message **Grid**. It is necessary to push buttons **K2** or **K3** to cancel the message before igniting again.

In functioning Wood the state of the sensor doesn't influence the running of the system.

If not used leave contact free.

4 ANALOGICAL INPUTS

In the table are the types of probes conditioned by the Control Board:





| PROBE | DESCRIPTION | TYPE | RANGE | PRECISION | VISUALIZATION | |
|-----------------|---|-------------------|---------|-----------|---------------|----------------|
| | | | | | PROBE OPEN | PROBE IN SHORT |
| Exhaust | Detecting of the Exhaust gas Temperature. | Thermo couple K | 0÷500°C | 1°C | Hi | Ambient Probe |
| Photoresistance | Detecting of the flame | Resistor variable | 0-100% | – | Lo | Hi |
| Boiler | Detecting of the temperature in the Boiler. | NTC10K | 0÷110°C | 1°C | Lo | Hi |
| Buffer | Detecting of the temperature in the Buffer | NTC10K | 0÷110°C | 1°C | Lo | Hi |

5 CONTROL BOARD

In the below figure is the image of the Control Board:













5.1 BUTTONS

| Button | Function |
|---|---|
|  SET 1 | <p>K1 pushed for 5 seconds activates the manual loading of the combustibile in the combustion chamber of the Boiler. The procedure can be done only with Boiler OFF. The Auger activation is when on the Display of the Control Board appears LoAd. The material is loaded until the button is pusher and the message is shown.</p> <p>In Menu manages the Visualization code/value of the parameters and the saving.</p> |
|  2 | <p>K2 pushed for 5 seconds changes the season Summer/Winter.</p> <p>In Menu manages the sliding and the decrease of the parameters' value</p> |
|  3 | <p>K3 pushed for 5 seconds starts the Ignition or Extinguishing.</p> <p>In Menu manages the sliding and the increase of the parameters' value</p> |
|  4 | <p>K4 pushed for 5 seconds allows the choice of the functioning modality among Wood, Pellet and combined. A brief pressure allows the exit the Menu in any moment in any state. During the modifying of the parameters allows to exit without saving the new value.</p> |

NOTE:

- In state **OFF** or **EXTINGUISHING**, in case of alarms, pushing the button **K2** or **K3** it is possible to end the Visualization. If present again after the reset, they are shown again.

5.2 LED

| LED | Function |
|--|--|
|  L1 | On for Auger on |
|  L2 | On for Combustion Fan on |
|  L3 | On for Boiler temperature less than A03 – A05 in Functioning Pellet On for Boiler temperature less than A03 – A80 in Functioning Wood Blinking for temperature more than above thermostats OFF for temperature more than A03 |
|  L4 | On if selected Functioning only Wood or Combined during the functioning Wood |
|  L5 | On if selected Functioning only Pellet or Combined during the functioning Pellet |
| Combi L6 | On if selected Functioning Combined Wood + Pellet |
|  L7 | On in modality Summer |
|  L8 | On in modality Winter |
|  L9 | On for Pump P1 on Blinking for Pump P1 deactivated form Ambient thermostat |
|  L10 | On for Diverter Valve/Pump P2 on |
|  L11 | On if Contact Ambient thermostat closed |
|  L12 | On if Contact chrono closed |
| Pr1 L13 | On if Program Pellet Pr1 selected |
| Pr2 L14 | On if Program Pellet Pr2 selected |

5.3 DISPLAY

- Display\Temperature\State\Alarms:** the 4 digit Display shows the water temperature in the Boiler, the name of the state and the alarms.
The abbreviations used are the following:

| Display | State | Display | State |
|------------|------------------|------------|------------------------|
| OFF | OFF | Mod | Modulation |
| Chc | Check Up | MAn | Standby |
| Acc | Ignition | Sic | Safety |
| Stb | Stabilization | SPE | Extinguishing |
| rEc | Recover Ignition | ALt | Boiler OFF with alarms |

If there are alarms that start EXTINGUISHING the display shows the message "**Alt**" alternated to the cause of error. The *error*, messages are the following:

| Display | DESCRIPTION | Display | DESCRIPTION |
|-------------|---------------------------------|-------------|-------------------------|
| tSic | Error Safety Rearmed thermostat | PELL | Lack of Combustible |
| CALd | Error Water Over temperature | FLUS | Flowswitch on |
| AccF | Error no Ignition | Grid | Grid on |
| SPAc | Error Accidental Extinguishing | tPEL | Pellet Thermostat Alarm |
| Sond | Probes out of range | | |

NOTE:

- When supplying with the Main Switch the display shows for 2 seconds the Product Code and the Firmware Version:

| Display | DESCRIPTION |
|---------------|-----------------------------|
| St 15 | Code for Combi STD3 product |
| Ur 1.0 | Firmware Version 1.0 |

6 MENU

The functioning parameters of the controller can be programmed with the Menu. There are 2 level's menu

- **User menu**
- **Protected Menu**

6.1 USER MENU

It is available pushing the button **K1** of the frontal panel. Then with buttons **K2** and **K3** it is possible to slide the parameters recognisable with the associated blinking led. The value is shown on the Display. The list of the parameters can change if some outputs is deactivated or according to the Functioning type selected (in Menu the selected functioning is indicated as: if Pellet the **Led L5** is On, if Wood **Led L4** is On, if Combi **Led L6** is On).

To modify the values follow the procedure:

- Chose the parameter to modify pushing **Buttons K2** or **K3** (the associated led blinks)
- Push **K1** to enter in modify (the value on the display blinks)
- Set the desired value with **Buttons K2 / K3** (pushing Buttons for 2 seconds, the digits change rapidly)
- To save the new value push **K1**
- To exit without saving push **K4**
- To exit the Menu manually push **K4**
- The system exit the Menu automatically after 30 seconds of no changing

NOTE: If the parameter is the value of a temperature read by the probe, on the Display appears the abbreviation. Pushing **K1** appears the value of the temperature.

User menu Parameters:

- **Pellet program from 1 to 2:** **Parameters only for chopped Combustible Functioning**
- **Wood program:** **Parameters only for Wood Functioning**

| LED | Abbrev | DESCRIPTION | Default Value | Minimum Value | Maximum Value |
|----------------|----------------|-----------------------------------|---------------|---------------|---------------|
| L2 | Uc05 | Combustion Fan Speed in Normal | Pellet 1 | Uc30 | Uc31 |
| | | | Pellet 2 | | |
| | | | Wood | | |
| L1* | CL05 | Auger Working Time in Normal | Pellet 1 | CL40 | CL41 |
| | | | Pellet 2 | | |
| | | | Wood | | |
| L1** | CU05 | Auger Speeding Normal | Pellet 1 | CU30 | CU31 |
| | | | Pellet 2 | | |
| | | | Wood | | |
| L3 | A03 | Boiler Thermostat for Standby | | A12 | A13 |
| L13/L14 | Pr | Combustion Pellet Recipe selected | | Pr1 | Pr2 |
| | Exhaust | Exhaust Temperature probe in °C | | | |

| | | | |
|--|-------------|--------------------------------|--|
| | Lum | Photoresistance Value in % | |
| | PuFF | Temperature Puffer Probe in °C | |

NOTE:

- The Parameters with value " - ", are not in Menu for that Combustion or Functioning program.
- The Parameters with value " **Not Used**", are in Menu for that Combustion or Functioning program but are not used by the system.
- The Comburent fan parameters **Uc20, Uc31** are in the Protected Menu.
- Auger parameters **CL40, CL41** o **CU30, CU31** are in the Protected Menu.
- The Parameters **A12** and **A13**, are the low and high of the Thermostat **A03**. The value is Programmable and is in the Protected menu.
- * Visible value if **P35** = 0,2 (Auger in functioning ON/OFF)
- ** Visible value if **P35** = 1,2 (Auger to Inverter)
- The parameter defined as **Combustion Program**, allows to select the list of the Parameters that regulate the Combustion with chopped Combustible (Pellet) of the system. It is possible to chose up to 2 lists of Parameters. Changing Programs, the value of the Parameters connected to the programs both in the User and in the Protected menu change, maintaining the same positions and names.
- The reading of the Photoresistance is visible in Menu only if activated (**P27** different to 0)
- The reading of the Puffer probe is visible only if selected a Plant with Puffer or sanitary Boiler (parameter **P37**)

6.2 PROTECTED MENU

It is available pushing together **K1** and **Button K3** of the frontal panel for 5 seconds after inserting the system password (default value 0000). In the Menu, with Buttons **K2** and **K3** slide the Parameters, recognisable with an abbreviation on the Display. To see the value of the selected parameter push **Button K1**. The list of the Parameters shown can change, if the use of some outputs is deactivated or according to the selected type of functioning (in Menu the selected functioning is indicated in this way: if Pellet the **Led L5** is On, if Wood the **Led L4** is On, if Combi the **Led L6** is On).

To modify the values follow the procedure:

- Chose the parameter to modify with **Buttons K2** or **K3** (the Display shows the name of the parameter)
- Push the button **Button K1** to enter in modify (the Display shows the value of the parameter)
- Set the desired value with **Buttons K2 / K3** (push Buttons for 2 seconds, the digit change rapidly)
- To save the new Value push the **Button K1**
- To exit without saving push **Button K4**
- To exit the menu manually push **Button K4**
- The system exit the Menu automatically after 60 seconds of no changing

Parameters Protected Menu:

- **Pellet Programs from 1 to 2:** Parameters only for Chopped combustible Functioning
- **Wood Program:** Parameters only for Wood Functioning

| Code | DESCRIPTION | Value Default | Value Minimum | Value Maximum |
|-------------|---|---------------|---------------|---------------|
| Uc00 | Combustion Fan Speed in Ignition Power 1 | Pellet 1 | Uc20 | 99 % |
| | | Pellet 2 | | |
| | | Wood | | |
| Uc01 | Combustion Fan Speed in Ignition Power 2 | Pellet 1 | Uc20 | 99 % |
| | | Pellet 2 | | |
| | | Wood | | |
| Uc04 | Combustion Fan Speed in Stabilization | Pellet 1 | Uc20 | 99 % |
| | | Pellet 2 | | |
| | | Wood | | |
| Uc07 | Combustion Fan Speed in Modulation | Pellet 1 | Uc20 | 99 % |
| | | Pellet 2 | | |
| | | Wood | | |

| | | | | | |
|-------------|--|----------|---|-------------|----------|
| Uc09 | Combustion Fan Speed in Standby | Pellet 1 | | Uc20 | 99 % |
| | | Pellet 2 | | | |
| | | Wood | | | |
| Uc10 | Combustion Fan Speed in EXTINGUISHING | Pellet 1 | | Uc20 | 99 % |
| | | Pellet 2 | | | |
| | | Wood | | | |
| Uc20 | Minimum Combustion Fan Speed set | | | 0 % | 99 % |
| Uc30 | Minimum Combustion Fan Speed in Normal settable in User Menu | | | Uc20 | 99 % |
| Uc31 | Maximum speed Combustion Fan in Normal settable in User Menu | | | Uc20 | 99 % |
| Uc81 | Combustion Fan Speed in case of backfire | | | Uc20 | 99 % |
| UA00 | Combustion Fan 2 Speed in Ignition Power 1 | Pellet 1 | | UA20 | 99 % |
| | | Pellet 2 | | | |
| | | Wood | | | |
| UA01 | Combustion Fan 2 Speed in Ignition Power 2 | Pellet 1 | | UA20 | 99 % |
| | | Pellet 2 | | | |
| | | Wood | | | |
| UA04 | Combustion Fan 2 Speed in Stabilization | Pellet 1 | | UA20 | 99 % |
| | | Pellet 2 | | | |
| | | Wood | | | |
| UA05 | Combustion Fan 2 Speed in Normal | Pellet 1 | | UA20 | 99 % |
| | | Pellet 2 | | | |
| | | Wood | | | |
| UA07 | Combustion Fan 2 Speed in Modulation | Pellet 1 | | UA20 | 99 % |
| | | Pellet 2 | | | |
| | | Wood | | | |
| UA09 | Combustion Fan 2 Speed in Standby | Pellet 1 | | UA20 | 99 % |
| | | Pellet 2 | | | |
| | | Wood | | | |
| UA10 | Combustion Fan 2 Speed in EXTINGUISHING | Pellet 1 | | UA20 | 99 % |
| | | Pellet 2 | | | |
| | | Wood | | | |
| UA20 | Minimum Combustion Fan 2 Speed settable | | | 0 % | 99 % |
| UA81 | Combustion Fan 2 Speed in case of backfire | | | UA20 | 99 % |
| CL00 | Auger Working Time in Ignition Power 1 | Pellet 1 | | 0 sec. | 600 sec. |
| | | Pellet 2 | | | |
| | | Wood | - | | |
| CL01 | Auger Working Time in Ignition Power 2 | Pellet 1 | | 0 sec. | 600 sec. |
| | | Pellet 2 | | | |
| | | Wood | - | | |
| CL04 | Auger Working Time in Stabilization | Pellet 1 | | 0 sec. | 600 sec. |
| | | Pellet 2 | | | |
| | | Wood | - | | |
| CL07 | Auger Working Time in Modulation | Pellet 1 | | 0 sec. | 600 sec. |
| | | Pellet 2 | | | |
| | | Wood | - | | |
| CL09 | Auger Working Time in Standby | Pellet 1 | | 0 sec. | 600 sec. |
| | | Pellet 2 | | | |
| | | Wood | - | | |

| | | | | | |
|-------------|--|----------|---|--------|-----------|
| CL40 | Minimum Auger Working Time in Normal settable in User Menu | Pellet 1 | | 0 | 600 sec. |
| | | Pellet 2 | | | |
| | | Wood | - | | |
| CL41 | Maximum Auger Working Time in Normal settable in User Menu | Pellet 1 | | 0 | 600 sec. |
| | | Pellet 2 | | | |
| | | Wood | - | | |
| CL81 | Auger Working Time in case of backfire | | | 0 sec. | 600 sec. |
| CP00 | Auger Pause Time in Ignition Power 1 | Pellet 1 | | 0 sec. | 600 sec. |
| | | Pellet 2 | | | |
| | | Wood | - | | |
| CP01 | Auger Pause Time in Ignition Power 2 | Pellet 1 | | 0 sec. | 600 sec. |
| | | Pellet 2 | | | |
| | | Wood | - | | |
| CP04 | Auger Pause Time in Stabilization | Pellet 1 | | 0 sec. | 600 sec. |
| | | Pellet 2 | | | |
| | | Wood | - | | |
| CP05 | Auger Pause Time In Normal | Pellet 1 | | 0 sec. | 600 sec. |
| | | Pellet 2 | | | |
| | | Wood | - | | |
| CP07 | Auger Pause Time in Modulation | Pellet 1 | | 0 sec. | 600 sec. |
| | | Pellet 2 | | | |
| | | Wood | - | | |
| CP09 | Auger Pause Time in Standby | Pellet 1 | | 0 sec. | 600 sec. |
| | | Pellet 2 | | | |
| | | Wood | | | |
| CU00 | Auger Speed in Ignition Power 1 | Pellet 1 | | 0 % | 100 % |
| | | Pellet 2 | | | |
| | | Wood | - | | |
| CU01 | Auger Speed in Ignition Power 2 | Pellet 1 | | 0 % | 100 % |
| | | Pellet 2 | | | |
| | | Wood | - | | |
| CU04 | Auger Speed in Stabilization | Pellet 1 | | 0 % | 100 % |
| | | Pellet 2 | | | |
| | | Wood | - | | |
| CU07 | Auger Speed in Modulation | Pellet 1 | | 0 % | 100 % |
| | | Pellet 2 | | | |
| | | Wood | - | | |
| CU09 | Auger Speed in Standby | Pellet 1 | | 0 % | 100 % |
| | | Pellet 2 | | | |
| | | Wood | - | | |
| CU30 | Auger Minimum speed in Normal settable in User Menu | Pellet 1 | | 0 % | 100 % |
| | | Pellet 2 | | | |
| | | Wood | - | | |
| CU31 | Maximum speed Auger in Normal settable in User Menu | Pellet 1 | | 0 % | 100 % |
| | | Pellet 2 | | | |
| | | Wood | - | | |
| CU81 | Auger Speed in case of backfire | | | 0 % | 100 % |
| F00 | Exhaust OFF Thermostat | Wood | | 30° C | Hi |

| | | | | | |
|-------------|--|--------|--|-------|------------|
| F02 | Exhaust ON Thermostat | Wood | | 30° C | Hi |
| F05 | Exhaust FAST Thermostat on Ignition | Wood | | 30° C | Hi |
| F06 | Exhaust Modulation Thermostat | Wood | | 30° C | Hi |
| F10 | Exhaust Thermostat Wood Ignition with Pellet in Combi 2 Mode | Wood | | 30° C | Hi |
| F16 | Exhaust ON Thermostat | Pellet | | 30° C | Hi |
| F18 | Exhaust ON Thermostat | Pellet | | 30° C | Hi |
| F21 | Exhaust FAST Thermostat on Ignition | Pellet | | 30° C | Hi |
| F22 | Exhaust Modulation Thermostat | Pellet | | 30° C | Hi |
| F26 | Exhaust ON Thermostat first Ignition in Combi 2 Mode | Pellet | | 30° C | Hi |
| F28 | Exhaust FAST Thermostat first Ignition in Combi 2 Mode | Pellet | | 30° C | Hi |
| F29 | Exhaust Thermostat Switch Pellet/Wood | Pellet | | 30° C | Hi |
| L00 | Photoresistance Thermostat OFF | | | 0 | 100 |
| L01 | Photoresistance Thermostat ON | | | 0 | 100 |
| IL00 | Thermostat Hysteresis L00 | | | 0 | 5 |
| IL01 | Thermostat Hysteresis L01 | | | 0 | 5 |
| A01 | Pump Thermostat | | | 20° C | 80° C |
| A04 | Boiler Thermostat for Safety | | | 80° C | 110° C |
| A05 | Temperature difference from A03-Boiler for Modulation Pellet functioning | | | 0° C | 20° C |
| A12 | Minimum Value settable for Boiler Thermostat | | | 40° C | 110° C |
| A13 | Maximum Value settable for Boiler Thermostat | | | 40° C | 110° C |
| A17 | Boiler Thermostat for Sanitary Activation | | | 20 °C | 80 °C |
| A18 | Thermostat Boiler for Sanitary Safety | | | 40 °C | 95 °C |
| A32 | Thermostat PROBE Boiler/Puffer for Puffer loading | | | 30 °C | 90 °C |
| A34 | Boiler/Puffer probe Thermostat for activation Plant Pump | | | 20 °C | 80 °C |
| d01 | Difference between Boiler temperature and Boiler for Pump activation loading Puffer/Boiler | | | 1 °C | 50 °C |

| | | | | |
|-------------|---|---------------|---------|----------|
| A80 | Temperature difference to A03 for Modulation in Wood functioning | | 0° C | 20° C |
| IF06 | Exhaust Thermostat Hysteresis for Modulation Wood | | 1° C | 40° C |
| IF22 | Exhaust Thermostat Hysteresis for Modulation Pellet | | 1° C | 40° C |
| IA01 | Boiler Hysteresis Thermostat for activation Pump Plant | | 1° C | 22° C |
| IA06 | Boiler Hysteresis Thermostat for Standby | | 1° C | 22° C |
| IA13 | Hysteresis Thermostat Boiler for Sanitary Activation | | 1 °C | 22 °C |
| IA14 | Hysteresis Thermostat Boiler for Sanitary Safety | | 1 °C | 22 °C |
| IA32 | Hysteresis Thermostat Boiler probe for Puffer loading | | 1 °C | 40 °C |
| IA34 | Hysteresis Thermostat Boiler probe for activation Pump Plant | | 1 °C | 40 °C |
| Id01 | Differential Hysteresis between Boiler and Boiler for activation Puffer/Boiler loading Pump | | 1 °C | 20 °C |
| t 00 | Time phase Pre-heating Igniter in Ignition with Pellet | | 0 sec. | 900 sec. |
| t01 | Time Ignition Phase1 | Pellet 1 | 0 min. | 300 min. |
| | | Pellet 2 | | |
| | | Wood Non used | | |
| t02 | Time Ignition Phase2 | Pellet 1 | 1 min. | 300 min. |
| | | Pellet 2 | | |
| | | Wood | | |
| t03 | Time Stabilization State | Pellet 1 | 0 min. | 300 min. |
| | | Pellet 2 | | |
| | | Wood | | |
| t04 | Waiting Time Phase in Maintenance | Pellet 1 | 1 min. | 300 min. |
| | | Pellet 2 | | |
| | | Wood | | |
| t05 | Time Phase of Maintenance in Standby | Pellet 1 | 0 sec. | 900 sec. |
| | | Pellet 2 | | |
| | | Wood | | |
| t06 | Waiting Time before Automatic EXTINGUISHING with Pellet | | 10 sec. | 900 sec. |
| t08 | Time State of Check Up or Cleaning in Ignition with Pellet | | 0 sec. | 900 sec. |
| t09 | Time phase of Cleaning in EXTINGUISHING with Pellet | | 0 sec. | 900 sec. |
| t15 | Delay on Pressure Switch Alarm | | 1 sec. | 900 sec. |
| t24 | Cleaning Time Engine OFF | | 0 min. | 600 min. |
| t25 | Cleaning Time Engine On | | 0 sec. | 900 sec. |
| t30 | Time OFF Cyclic Auger Functioning | | 1 min | 99 min |

| | | | | |
|------------|--|----------|---------|-----------|
| t31 | Time ON Cyclic Auger Functioning | | 0 sec. | 300 sec. |
| t38 | Maximum time of opening of pellet thermostat contact before the system goes into Extinguishing | | 1 sec. | 3600 sec. |
| t55 | Alarm Time Filling | | 10 sec. | 900 sec. |
| t56 | Time Tank loading | | 0 sec. | 900 sec. |
| t72 | Time Opening Pellet Shutter | | 0 sec. | 900 sec. |
| t73 | Waiting Time before Automatic Extinguishing with Wood | | 1 min. | 300 min. |
| t74 | Phase 1 Time to Ignition Wood from Pellet | | 0 sec. | 900 sec. |
| t75 | Phase 2 Time to Ignition Wood from Pellet | | 0 sec. | 900 sec. |
| t89 | Time Cleaning phase in Extinguishing with Wood | | 0 sec. | 900 sec. |
| t90 | Delay Extinguishing Auger2 | | 0 sec. | 900 sec. |
| P02 | Number of attempts Ignition repetition | | 1 | 5 |
| P03 | Selection functioning Input Chrono | | 0 | 1 |
| P04 | Selection functioning Input Ambient thermostat | | 0 | 2 |
| P08 | Activation Extinguishing State | | 0 | 1 |
| P15 | Activation Combustion Fan 2 at Maximum with open Door | | 0 | 1 |
| P27 | Input 1 Configuration | | 0 | 4 |
| P30 | Activation Combustion Fan Functioning | Pellet 1 | 0 | 1 |
| | | Pellet 2 | | |
| | | Wood | | |
| P31 | Activation Combustion Fan 2 Functioning | Pellet 1 | 0 | 1 |
| | | Pellet 2 | | |
| | | Wood | | |
| P35 | Configuration Inverter | | 0 | 4 |
| P37 | Configuration Hydraulic Plant | | 0 | 6 |
| P54 | Configuration Pellet probe reading | | 0 | 2 |
| P59 | Configuration Output OUT2 | | 0 | 28 |
| P60 | Configuration Output OUT4 | | 0 | 28 |
| P61 | Configuration Output OUT AUX | | 0 | 28 |
| P72 | Increasing percentage of Auger 2 time On respect to Auger 1 time On | | 0 % | 800 % |
| P73 | Combustion Fan Max Speed when Door Open | | 0 | 1 |
| P78 | Activation Pump on for Circulation in Summer | | 0 | 1 |
| P82 | Air valve activation based on Modality | | 0 | 2 |
| P88 | Functioning Configuration | | 0 | 4 |
| P91 | Input 2 Configuration | | 0 | 2 |

NOTE:

- Parameters with Value as symbol " - ", are not in Menu for that Program of Combustion or Functioning.
- Parameters with Value as " **Not Used** ", are in Menu for that Program of Combustion or Functioning but are not used by the System.
- Augers functioning with separate times ON/OFF:
 - Parameters defined as **Auger working times**, are the seconds of activation of the Auger, Programmable for the expected functioning **STATES**.
 - Parameters defined as **Auger pause times**, are the seconds of EXTINGUISHING of the Auger, Programmable for the expected functioning **STATES**.
 - If Time **Work** of the Auger is set 0 seconds, Auger is deactivated.
 - If Time **Pause** of the Auger is set 0 seconds, Auger runs without stopping.
 - The Regulation of the Auger in Menu is with steps of 0,5 seconds.
- The parameter **Uc20**, is the Minimum Value settable for the Combustion Fan and must be set, according to the fan used. If the Value of this parameter is set more than some Fan parameter, the system automatically set the **Uc20** (only if value "0" is not modified, to let the fan extinguish in some states).
- The parameter **UA20**, is the Minimum Value settable for the Combustion Fan 2 and must be set, according to the fan used. If the Value of this parameter is set more than some Fan parameter, the system automatically set the **Uc20** (only if value "0" is not modified, to let the fan extinguish in some states).
- **Exhaust thermostats** that can be set until **Hi (901° C)**, have the possibility to be deactivated. Being the last good Value settable **900° C**, putting one as **Hi** makes them not to run.
- The parameter **A05** is the temperature value, that detracted from the Value of the Boiler Thermostat **A03**, gives the Value of the Thermostat for the Input in **MODULATION** in the functioning with **Pellet**. If this parameter is set like 0° C, the State of **MODULATION** in functioning with Pellet for Boiler temperature is not executed.
- The parameter **A12** is the Minimum Value for the Thermostat **A03**, in the User Menu.
- The parameter **A13** is the Maximum Value for the Thermostat **A03**, in the User Menu.
- The parameter **A80** is the Value of Temperature, that detracted from the Value of the Boiler Thermostat **A03**, gives the Value of the Thermostat for the Input in **MODULATION** in the functioning with **Wood**. If this parameter is set like 0° C, the State of **MODULATION** in functioning with Wood for Boiler temperature is not executed.
- The parameter **P02** is the number of attempts to repeat the Ignition, in case of missing Combustion. If this parameter is set like 1, the Ignition is not repeated.
- The parameter **P03** manages the functioning of the Contact Chrono:
 - Setting as 0 the Chrono manages Ignition/EXTINGUISHING of the system.
 - Setting as 1 the Chrono turns the system in **STANDBY**
- The parameter **P04** manages the functioning of the Contact thermostat:
 - Setting as 0 the Ambient thermostat manages the functioning of the Pump.
 - Setting as 1 the Ambient thermostat turns the system in **STANDBY**
 - Setting as 2 the Ambient thermostat manages the Ignition/EXTINGUISHING of the system.
- The parameter **P08** activates/deactivates the State of EXTINGUISHING of the system:
 - Setting as 0 the control does not execute the State EXTINGUISHING
 - Setting as 1 the State is executed, with the possibility of a Final Cleaning.
- The parameter **P15** manages the functioning Combustion Fan 2 when opening Door of boiler:
 - Setting as 0 the Combustion Fan 2 is deactivated
 - Setting as 1 the Combustion Fan 2 runs at the Maximum speed
- The parameter **P27** allows the configuration of Input 1
 - Setting as 0 the input is not used
 - Setting as 1 the input is used as Grid Sensor
 - Setting as 2 or 3 the input is used as Photoresistance
 - Setting as 4 the input is used as Pellet Thermostat

NOTE: The combustion sensor is Thermo couple only if **P27** = 0,1,4; Photoresistance only if **P27** = 2; Thermo couple and Photoresistance if **P27** = 3.
- The Parameters **P30, P31**, activate/deactivate the functioning of some outputs of the controller:
 - P30 Setting as 0 deactivates the Combustion Fan and its Parameters disappears from the Menu.
 - P31 Setting as 0 deactivates la Combustion Fan 2 and its Parameters disappear from Menu.
- The parameter **P35** allows the user to choose the Inverter functioning mode:
 - Set to 0 the Inverter not used
 - Set to 1 the Inverter manages the Auger in continuous
 - Set to 2 the Inverter manages the Auger in pause/work mode
 - Set to 3 the Inverter manages Combustion Fan
 - Set to 4 the Inverter manages Combustion Fan 2

- The parameter **P54** selects the reading modality of the input combustible level:
 - Setting as 0 the Input is deactivated
 - Setting as 1 the controller with the presence of Combustible waits to read an Input Normally closed or a high level tension (5V o 12V)
 - Setting as 2 the controller with the presence of Combustible waits to read an Input Normally open or a low level tension (0V)
- The parameter **P59** allows the Configuration of the Output see par. Configurable Outputs management.
- The parameter **P60** allows the Configuration of the Output OUT4 see par. Configurable Outputs management.
- The parameter **P61** allows the Configuration of the Output OUT AUX see par. Configurable Outputs management
- The parameter **P73** manages the functioning Combustion Fan when when opening Door of boiler:
 - Setting as 0 the Combustion Fan is deactivated
 - Setting as 1 the Combustion Fan runs at the Maximum speed
- The parameter **P90** Activates/Deactivates the management of the Modem GSM:
 - Setting as 0 the Modem GSM is Deactivated or, or the controller is checked only with a local computer
 - Setting as 1 the Modem GSM is Activated, the controller is checked but with a local and remote computer
- Parameter **P91** allows the configuration of Input 2
 - Setting as 0 the input is not used
 - Setting as 1 the input is used as Pressure Switch
 - Setting as 2 the input is used as Pellet Thermostat

According to the selected Hydraulic plant, some Menu Parameters are not visible:

- Parameters **A32** e **IA32** are visible only if **P37 = 2 - 3**
- Parameters **A34** e **IA34** are visible only if **P37 = 4**
- Parameters **d01** e **Id01** are visible only if **P37 = 2 – 3 – 4**

6.3 NOT PROGRAMMABLE PARAMETERS

In this table are the Parameters that cannot be programmed through the Control Board. Parameters can be modified through the System Evolution.

Not Programmable Parameters table

| Thermostat Abbreviation | DESCRIPTION | Value |
|-------------------------|-----------------------------|-------|
| A00 | Antifreeze Thermostat | 5° C |
| A07 | Thermostat Boiler for Alarm | 95° C |

Hysteresis thermostat table

| Abbreviation | DESCRIPTION | Value Hysteresis |
|--------------|---------------------------|------------------|
| IF00 | F00 Hysteresis Thermostat | 2° C |
| IF02 | F02 Hysteresis Thermostat | 2° C |
| IF05 | F05 Hysteresis Thermostat | 2° C |
| IF10 | F10 Hysteresis Thermostat | 2° C |
| IF16 | F16 Hysteresis Thermostat | 2° C |
| IF18 | F18 Hysteresis Thermostat | 2° C |
| IF21 | F21 Hysteresis Thermostat | 2° C |
| IF26 | F26 Hysteresis Thermostat | 2° C |
| IF28 | F28 Hysteresis Thermostat | 2° C |
| IA00 | A00 Hysteresis Thermostat | 0° C |
| IA07 | A04 Hysteresis Thermostat | 2° C |
| IA08 | A07 Hysteresis Thermostat | 2° C |
| IL00 | L00 Hysteresis Thermostat | 0% |
| IL01 | L01 Hysteresis Thermostat | 0% |

NOTE:

- The functioning thermostats of the system are considered by the controller in the following way:
- In phase of **Increasing Temperature**
Take the **Value of Thermostat** (Ex: **A03 = 65°C**)
- In phase of **Decreasing Temperature**
Take the **Value of Thermostat – its Hysteresis** (Ex: **A03 = 65° - 3° = 62°C**)

7 FUNCTIONING STATES

The controller **SY325** is composed by two parts:

- ◆ **Main board** whose connectors have to be connected as in chapter **Installation**
- ◆ **Control Board**

The functioning of the board SY325 is managed for **States**, each characterised by the verifying of the conditions of the main functioning Parameters of the Boiler, for example the Exhaust temperature inside the Combustion chamber, the Water Temperature in Boiler, the work of Securities and so the verifying of functioning errors.

The quantity of combustion managed by each state is regulated by **Functioning Powers**. Each Power is composed by the measures:

- **Combustion Fan Speed**
- **Aspiration fan Speed**
- **Auger functioning times**

Regulating these Parameters we can define the quantity of combustible and air used.

The group of powers that regulate the functioning of the controller is called **Combustion Program**. It is possible to select up to 2 programs for chopped combustible and 1 program for Wood.

Below all the Functioning state of the system and the management of the inputs, outputs, and the messages.

| | |
|----|-------------------------|
| 1 | OFF |
| 2 | CHECK UP |
| 3 | IGNITION |
| 4 | STABILIZATION |
| 5 | RECOVER IGNITION |
| 6 | NORMAL |
| 7 | MODULATION |
| 8 | STANDBY |
| 9 | SAFETY |
| 10 | EXTINGUISHING |

The system guarantees the reading of the SAFETY and ALARMS states in each functioning phase.

7.1 FUNCTIONING CONFIGURATION

By changing the parameter **P88** is possible to act on the operation of the system, in particular, the following configurations are available:

- ✓ **P88 =0**:Functioning only Pellet
- ✓ **P88 =1**:Functioning COMBI 1; the system can operate pellet, wood, and in a combined way.
- ✓ **P88 =2**:Functioning COMBI 2, the system can operate pellet, wood, and in a combined way.
- ✓ **P88 =3**:Functioning Pellet/Wood; the system can operate wood or pellet.
- ✓ **P88 =4**:Functioning only Wood

PELLET FUNCTIONING

7.1.1 OFF

This state is after the phase of **EXTINGUISHING** if:

P27 = 0,1,4 and the Exhaust Temperature is less than Thermostat **F16**

P27 = 2 and the brightness is less than the level **L00**

P27 = 3 and the Exhaust Temperature is less than Thermostat **F16** and the brightness is less than **L00**

| Display Visualization | Combustion Fan | Combustion Fan 2* | Auger | Igniter |
|---|----------------|-------------------|-------|---------|
| Temperature in Boiler alternated to the message OFF . Possible Alarm messages | OFF | OFF | OFF | OFF |

If The parameter **P08** is **1** the system turns to **EXTINGUISHING** if:

P27 = 0,1,4 and the Exhaust Temperature is over the Thermostat value **F16**

P27 = 2 and the brightness is over **L00**

P27 = 3 and the Exhaust Temperature is over the Thermostat value **F16** or the brightness is over **L00**

* **If active in the Configurable Outputs.**

7.1.2 CHECK UP

This State with length Programmable, allows the Cleaning of the Combustion chamber before the procedure of **IGNITION**. Its length is like the Value of **t08**.

To enter this State:

➤ Push the **Button K3** of the Control Board from State **OFF** or **EXTINGUISHING**

ATTENTION: Ignition is not allowed with Alarms o Door open.

| Display Visualization | Combustion Fan | Combustion Fan 2* | Auger | Igniter |
|---|----------------|-------------------|-------|---------|
| Temperature in Boiler alternated to the message Chc . Message Sond in case of check probes not correct | 99% | 99% | OFF | OFF |

In this phase and the Controller tests the Temperature probes connected. If the controller reads the Temperature values at the Maximum or Minimum of the ranges allowed, on the display is **Sond**. This Error does not modify the Boiler functioning, but it is only a warning to verify if the probes' reading is correct.

To bypass this State set the Value t08 as 0.

End of CHECK-UP state:

➤ After a provided Time for the phase Check-Up the system starts the functioning **IGNITION**

➤ The system starts the functioning **NORMAL** if:

P27 = 0,1,4 and the Exhaust Temperature is more than **F21**

P27 = 2 and the Value of brightness is more than **L01**

P27 = 3 and the Exhaust Temperature is more than **F21** e and the Value of brightness is more than **L01**

➤ If the Boiler temperature is more than Thermostat **A04** the system starts the functioning **SAFETY**

* **If activated on the Configurable Outputs.**

7.1.3 IGNITION

Starts in the following cases:

➤ At the Output of the state **CHECK-UP**

➤ At the end of the state **STANDBY**

The State **IGNITION** is divided into 3 parts, each with Programmable length:

◆ **Pre-heating (Igniter)**

The phase brings in Temperature the element Igniter before the fall of the pellet in the brazier. Its length is the value **t00**.

| Display Visualization | Combustion Fan | Combustion Fan 2* | Auger | Igniter |
|---|----------------|-------------------|-------|-----------|
| Temperature in Boiler alternated to the message Acc | Uc00 | UA00 | OFF | ON |

To bypass this State set the Value **t00** as **0**.

* If activated on the Configurable Outputs.

◆ **Phase 1 (Fixed Ignition)**

- ◆ The phase loads the Combustible on the brazier and starts the Ignition of the flame with new start also hot- start. Its length is the parameter **t01**.

| Display Visualization | Combustion Fan | Combustion Fan 2* | Auger | | | Igniter |
|---|----------------|-------------------|-----------------------------|------------------------|-------------------------------------|-----------|
| Temperature in Boiler alternated to the message Acc | Uc00 | UA00 | P35 = 0 CL00/CP00 | P35 = 1 CU00 | P35 = 2 CU00 CL00/CP00 | ON |

To bypass this State set the Value **t01** a **0**.

* If activated on the Configurable Outputs.

◆ **Phase 2 (Variable Ignition)**

The phase strength and maintain the flame in the Combustion chamber before passing the next state. The length is the parameter **t02**.

| Display Visualization | Combustion Fan | Combustion Fan 2* | Auger | | | Igniter |
|---|----------------|-------------------|-----------------------------|------------------------|-------------------------------------|-----------|
| Temperature in Boiler alternated to the message Acc | Uc01 | UA01 | P35 = 0 CL01/CP01 | P35 = 1 CU01 | P35 = 2 CU01 CL01/CP01 | ON |

End of the State IGNITION:

- **For first Ignition** (pushing **Button ON** of the Control Board)
 - in every phase of Ignition the system starts the functioning **NORMAL** if
P27 = 0,1,4 and the Exhaust Temperature is more than **F21**
P27 = 3 and the Exhaust Temperature is more than **F21** and the Value of the brightness is over **L01**
 - in the phase 2 of the Ignition the system starts the functioning **STABILIZATION** if
P27 = 0,1,4 and the Exhaust Temperature is more than **F18**
P27 = 2 and the Value of the brightness is more than **L01**
P27 = 3 and the Exhaust Temperature is more than **F18** and the Value of the brightness is more than **L01**
- **For further ignitions** (at the end of **STANDBY**)
 - in every phase of Ignition the system starts the functioning **NORMAL** if
P27 = 0,1,4 and the Exhaust Temperature is more than **F21**
P27 = 3 and the Exhaust Temperature is more than **F21** and the Value of the brightness is more than **L01**
 - In the phase 2 of Ignition the system starts the functioning **NORMAL** if
P27 = 0,1,4 and the Exhaust Temperature is more than **F18**
P27 = 2 and the Value of the brightness is more than **L01**
P27 = 3 and the Exhaust Temperature is more than **F18** and the Value of the brightness is more than **L01**
- **For fall ignitions**
 - At the end of the phases of Ignition the system **tries again** the Ignition to the Maximum programmed number of attempts (parameter **P02**) if
P27 = 0,1,4 and the Exhaust Temperature is less than **F18**
P27 = 2 and the Value of the brightness is under **L01**
P27 = 3 and the Exhaust Temperature is less than **F18** or the Value of the brightness is under **L01**

- If the number of attempts is finished the system starts **EXTINGUISHING** with message of Failed Ignition **ALt AccF**
 - If the Boiler temperature is more than Thermostat **A04** the system starts the functioning **SAFETY**
- * If activated on the Configurable Outputs.**

7.1.4 STABILIZATION

Starts at the end of **IGNITION**.

The phase stabilises and strength the Combustion before passing to the state **NORMAL**. Its length is Programmable and as the parameter **t03**.

| Display Visualization | Combustion Fan | Combustion Fan 2* | Auger | | | Igniter |
|--|----------------|-------------------|-----------|---------|-------------------|---------|
| | | | P35 = 0 | P35 = 1 | P35 = 2 | |
| Temperature in Boiler alternated to the message Stb | Uc04 | UA04 | CL04/CP04 | CU04 | CU04 CL04/CP04 | OFF |
| | | | | | | |

To bypass this state set the value of t03 as 0.

End of STABILIZATION:

- with Time not expired the system starts the functioning **NORMAL** if **P27 = 0,1,4** and the Exhaust Temperature is more than **F21**
- at the end of Time Stabilization the system starts the functioning **NORMAL** if **P27 = 0,1,4** and the Exhaust Temperature is more than **F18**
P27 = 2 and the Value of the brightness is more than **L01**
P27 = 3 and the Exhaust Temperature is more than **F18** and the Value of the brightness is more than **L01**
- If the Boiler temperature is more than **A03** during the phase Stabilization the system starts the functioning **STANDBY**
- During the phase Stabilization the system **tries again** the Ignition until the Maximum number of attempts programmed (parameter **P02**) if
P27 = 0,1,4 and the Exhaust Temperature is less than **F18**
P27 = 2 and the Value of the brightness is under **L01**
P27 = 3 and the Exhaust Temperature is less than **F18** or the Value of the brightness is less than **L01**
- If the number of attempts is empire the system starts **OFF** with message Failed Ignition **ALt AccF**
- If the boiler temperature is more than Thermostat **A04** the system starts the functioning **SAFETY**

*** If activated on the Configurable Outputs.**

7.1.5 RECOVER IGNITION

The State activates for a **hole of supply**.

| | | |
|-----------------------|---|--|
| Display Visualization |  | Temperature in Boiler alternated to the message rEc |
|-----------------------|---|--|

The phase makes a **restoration** of the state for a supply hole with the sequence:

- **ANALISYS SYSTEM'S ACTUAL STATE** (length about 5 seconds)
- **IGNITION**

7.1.6 NORMAL

Starts in the following cases:

- After the states **IGNITION/STABILIZATION**
- At the Output of **MODULATION**

| Display Visualization | Combustion Fan | Combustion Fan 2* | Auger | | | Igniter |
|-----------------------|----------------|-------------------|-----------|---------|-------------------|---------|
| | | | P35 = 0 | P35 = 1 | P35 = 2 | |
| Temperature in Boiler | Uc05 | UA05 | CL05/CP05 | CU05 | CU05 CL05/CP05 | OFF |
| | | | | | | |

End of the State NORMAL:

- If the Exhaust Temperature is more than **F22** the system starts the functioning **MODULATION**
- If the Boiler temperature is more than **A03 –A05** the system starts the functioning **MODULATION**
- If the Boiler temperature is more than **A03** the system starts the functioning **STANDBY**
- The system waits for a Time **t06** than starts **EXTINGUISHING** with message Accidental **EXTINGUISHING**
Alt SPAc if
P27 = 0,1,4 and the Exhaust Temperature is less than **F16**
P27 = 2 and the Value of the brightness is sotto a **L00**
P27 = 3 and the Exhaust Temperature is less than **F16** or the value of the brightness is less than **L00**

* **If activated on the Configurable Outputs.**

7.1.7 MODULATION

The system starts this state in the following cases:

- If the Exhaust Temperature is more than **F22**
- If the Boiler temperature is more than **A03 –A05**

This phase is to reduce the Combustion in order to arrive gradually to the Thermostat **A03**, or low the Exhaust Temperature.

| Display Visualization | Combustion Fan | Combustion Fan 2* | Auger | | | Igniter |
|---|----------------|-------------------|------------------|----------------|------------------|---------|
| | | | P35 = 0 | P35 = 1 | P35 = 2 | |
| Temperature in Boiler alternated to the message Mod | Uc07 | UA07 | CL07/CP07 | CU07 | CU07 | OFF |
| | | | | | CL07/CP07 | |

End of the state MODULATION:

- If the Exhaust Temperature is less than **F22** the system turns back to functioning **NORMAL**
- If the Boiler temperature is less than **A03 – A05** the system turns back to functioning **NORMAL**
- If the Boiler temperature is more than **A03** the system starts functioning **STANDBY**
- the system waits for a time **t06** and then starts **EXTINGUISHING** with message of accidental **Alt SPAc** if
P27 = 0,1,4 and the Exhaust Temperature is less than **F16**
P27 = 2 and the Value of the brightness is less than **L00**
P27 = 3 and the Exhaust Temperature is less than **F16** or the Value of the brightness is less than **L00**

* **If activated on the Configurable Outputs.**

7.1.8 STANDBY

The system starts this state in the following cases:

- If the Boiler temperature is more than **A03**

The State **STANDBY** is divided into 2 continuum cycle phases each with length Programmable. The aim is to strongly reduce the Combustion avoiding the state **SAFETY**, granting, the Maintenance of the embers for the next Ignition.

◆ **Pause Phase**

The phase is to reduce to the Minimum the Combustion. Its length is Programmable and as the parameter **t04**.

| Display Visualization | Combustion Fan | Combustion Fan 2* | Auger | Igniter |
|---|----------------|-------------------|-------|---------|
| Temperature in Boiler alternated to the message MAn | OFF | OFF | OFF | OFF |

◆ **Phase of Maintenance**

The phase is to load the Minimum combustibile to avoid the boiler's **EXTINGUISHING**. Its length is Programmable and as the parameter **t05**.

| Display Visualization | Combustion Fan | Combustion Fan 2* | Auger | | | Igniter |
|--|----------------|-------------------|----------------|----------------|-------------------|---------|
| Temperature in Boiler alternated to the message MA n | Uc09 | UA09 | P35 = 0 | P35 = 1 | P35 = 2 | OFF |
| | | | CL09/CP09 | CU09 | CU09 CL09/CP09 | |

To bypass this State set the Value **t05** a 0.

ATTENTION:

- If the 2 Augers must do Pause/Work in the phase MAINTENANCE, the addition of the programmed times for Pause and for Work must be less than Time **t05**.
- If the Augers must be always active during the phase MAINTENANCE, set the work times 0 seconds.
- If the Augers must stop during the phase MAINTENANCE, set the work times 0 seconds.

End of the State STANDBY:

- If the Boiler temperature is less than **A03 – IA06** the system starts **IGNITION**
- If the Boiler temperature is more than **A04** the system starts **SAFETY**

* If activated on the Configurable Outputs.

7.1.9 SAFETY

The system starts this state in the following case:

- If the Boiler temperature is more than **A04**

The State is to signal and control the system’s safety conditions

| Display Visualization | Combustion Fan | Combustion Fan 2* | Auger | Igniter |
|---|----------------|-------------------|-------|---------|
| Temperature in Boiler alternated to the messages Man and Sic | OFF | OFF | OFF | OFF |

At the passing of the Thermostat **A04**, starts the functioning Safety but the message on the Display is always **Man**. If the Temperature of the Water increases becoming more than Thermostat **A07**, the Display shows **Sic** and activates an acoustic Alarm.

End of the State SAFETY:

- If the Boiler temperature is less than **A04** the system turns back to functioning **STANDBY**

* If activated on the Configurable Outputs.

7.1.10 EXTINGUISHING

The system starts this state in the following cases:

- Through the **Button OFF** of the Control Board from every State
- According to the used probe if:
 - P27 = 0,1,4** and Exhaust Temperature less than Thermostat **F16**
 - P27 = 2** and the Value of the brightness is less than **L00**
 - P27 = 3** and the Exhaust Temperature is less than **F16** or the Value of the brightness is less than **L00**
- For the start of other **Alarms**

The State is divided into **2 phases**:

◆ **EXTINGUISHING**

For the EXTINGUISHING of the flame and the disposal of the remaining heat to bring:

- the Exhaust Temperature under the Thermostat **F16** if **P27 = 0,1,4**
- the Value of the brightness under **L00** if **P27 = 2**
- the Exhaust Temperature under the Thermostat **F16** and the Value of the brightness under **L00** if **P27 = 3**

| Display Visualization | Combustion Fan | Combustion Fan 2* | Auger | Igniter |
|---|----------------|-------------------|-------|---------|
| Temperature in Boiler alternated to the message SPE Other Alarm messages | Uc10 | UA10 | OFF | OFF |

◆ **Final Cleaning**

For the final Cleaning of the brazier for a Programmable time **t09**.

| Display Visualization | Combustion Fan | Combustion Fan 2* | Auger | Igniter |
|---|----------------|-------------------|-------|---------|
| Temperature in Boiler alternated to the message SPE Other Alarm messages | 99% | 99% | OFF | OFF |

ATTENTION: If the Temperature of the Water in Boiler goes over Thermostat **A03** in both phases, for the security the Combustion Fan is deactivated. The fan turns on when the Boiler temperature is under **A03-IA06**.

To bypass the phase of Cleaning set the Value **t09** as **0**.

To bypass the phase of EXTINGUISHING set **P08** as **0**.

End of the state EXTINGUISHING:

- at the end of the phase FINAL CLEANING the system starts functioning **OFF**

* **If activated on the Configurable Outputs.**

7.2 WOOD FUNCTIONING

7.2.1 OFF

It is the Stand-By state of the system. It starts after the phase **EXTINGUISHING** with:

- Exhaust Temperature less than Thermostat **F00**

| Display Visualization | Combustion Fan | Combustion Fan 2* | Auger | Igniter |
|---|----------------|-------------------|-------|---------|
| Temperature in Boiler alternated to the message OFF . Other Alarm messages | OFF | OFF | OFF | OFF |

If the Exhaust Temperature goes over the Value of the Thermostat **F00** and the parameter **P08** is **1**:

- The system starts **EXTINGUISHING**.
- * **If activated on the Configurable Outputs.**

7.2.2 IGNITION

It starts in the following cases:

- pushing the **Button K3** of the Control Board from State **OFF** or **EXTINGUISHING**

ATTENTION: the Ignition is not allowed with Alarms or open Door.

The State **IGNITION** starts the Ignition of the flame in the Combustion chamber and strength it before passing to the following state. Its length is Programmable and as parameter **t02**.

| Display Visualization | Combustion Fan | Combustion Fan 2* | Auger | Igniter |
|--|----------------|-------------------|---|---------|
| Temperature in Boiler alternated to the message Acc | Uc00 | UA00 | OFF t30 minutes ON t31 seconds | OFF |

End of the State IGNITION:

- If the Exhaust Temperature is more than **F05** the system starts functioning **NORMAL**
 - If the Exhaust Temperature is more than **F02** the system starts functioning **STABILIZATION**
 - If the Exhaust Temperature is less than **F02** after the Time Ignition the **tries again** Ignition until the Maximum number of programmed attempts. (parameter **P02**)
 - If the number of attempts is over the system starts **EXTINGUISHING** with message of Failed Ignition **Alt AccF**
 - If the Boiler temperature is more than Thermostat **A04** the system starts functioning **SAFETY**
- * If activated on the Configurable Outputs.**

7.2.3 STABILIZATION

It starts after the State **IGNITION**.

the phase stabilises and strength the Combustion before passing to the State **NORMAL**. Its length is Programmable and is as parameter **t03**.

| Display Visualization | Combustion Fan | Combustion Fan 2* | Auger | Igniter |
|--|----------------|-------------------|---|---------|
| Temperature in Boiler alternated to the message Stb | Uc04 | UA04 | OFF t30 minutes ON t31 seconds | OFF |

To bypass this state set the value of t03 as 0.

End of the State STABILIZATION:

- If the Exhaust Temperature is more than **F05** with Time Stabilization not ended the system starts the functioning **NORMAL**
- If the Exhaust Temperature is more than **F02** at the end of Time Stabilization the system starts functioning **NORMAL**
- If the Boiler temperature is more than **A03** during the phase Stabilization the system starts functioning **STANDBY**
- If the Exhaust Temperature is less than **F02** during the phase Stabilization the system **tries again** the Ignition until the maximum number of programmed attempts (parameter **P02**)
- If the number of attempts is finished the system starts **OFF** with message of Failed Ignition **Alt AccF**
- If the Boiler temperature is more than Thermostat **A04** the system starts functioning **SAFETY**

*** If activated on the Configurable Outputs.**

7.2.4 RECOVER IGNITION

The State activates for a **hole of supply**.

| | | |
|------------------------------|---|--|
| Display Visualization |  | Temperature in Boiler alternated to the message rEc |
|------------------------------|---|--|

The phase is to recover the state when there is a hole of supply according to the sequence:

- **SYSTEM'S ACTUAL STATE ANALYSIS** (length about 5 seconds)
- **LAST SAVED STATE**

7.2.5 NORMAL

It starts in the following cases:

- At the end of **IGNITION/STABILIZATION**
- at the output of the state **MODULATION**

| Display Visualization | Combustion Fan | Combustion Fan 2* | Auger | Igniter |
|-----------------------|----------------|-------------------|---|---------|
| Temperature in Boiler | Uc05 | UA05 | OFF t30 minutes ON t31 seconds | OFF |

End of the state NORMAL:

- If the Exhaust Temperature is more than Thermostat **F06** the system starts functioning **MODULATION**
- If the Boiler temperature is more than **A03 –A80** the system starts functioning **MODULATION**
- If the Boiler temperature is more than **A03** the system starts functioning **STANDBY**
- If the Exhaust Temperature is less than Thermostat **F00** the system waits for a time **t73** then starts **EXTINGUISHING** with message Accidental extinguishing **ALt SPAc**

* **If activated on the Configurable Outputs.**

7.2.6 MODULATION

The system starts this state in the following cases:

- If the Exhaust Temperature is more than **F06**
- If the Boiler temperature is more than **A03 –A80**

The phase is to reduce the Combustion in order to arrive gradually to the Thermostat **A03**, or to low the Exhaust Temperature.

| Display Visualization | Combustion Fan | Combustion Fan 2* | Auger | Igniter |
|--|----------------|-------------------|---|---------|
| Temperature in Boiler alternated to the message Mod | Uc07 | UA07 | OFF t30 minutes ON t31 seconds | OFF |

End of the state MODULATION:

- If the Exhaust Temperature is less than **F06** the system turns back to functioning **NORMAL**
- If the Boiler temperature is less than **A03 – A80** the system turns back to functioning **NORMAL**
- If the Boiler temperature is more than **A03** the system starts functioning **STANDBY**
- If the Exhaust Temperature is less than Thermostat **F00** the system waits for a time **t73** then starts **EXTINGUISHING** with message Accidental extinguishing **ALt SPAc**

* **If activated on the Configurable Outputs.**

7.2.7 STANDBY

The system starts this state in the following cases:

- If the Boiler temperature is more than **A03**

The state **STANDBY** is divided into 2 continuum cycle phases each with programmable length. The aim is to reduce strongly the Combustion avoiding the State **SAFETY**, granting the Maintenance of the embers for the next Ignition.

◆ **Phase of Pause**

The phase is to reduce the combustion to the minimum. Its length is Programmable and as the parameter **t04**.

| Display Visualization | Combustion Fan | Combustion Fan 2* | Auger | Igniter |
|---|----------------|-------------------|---|---------|
| Temperature in Boiler alternated to the message MAAn | OFF | OFF | OFF t30 minutes ON t31 seconds | OFF |

◆ **Phase of Maintenance**

The phase is to load the combustibile at the minimum tot to let the Boiler turn off. Its length is Programmable and as the parameter **t05**.

| Display Visualization | Combustion Fan | Combustion Fan 2* | Auger | Igniter |
|---|----------------|-------------------|---|---------|
| Temperature in Boiler alternated to the message MAAn | Uc09 | UA09 | OFF t30 minutes ON t31 seconds | OFF |

To bypass this State set the Value **t05** as **0**.

End of the state STANDBY:

- If the Boiler temperature is less than **A03** the system starts **NORMAL**
- If the Boiler temperature is more than **A04** the system starts functioning **SAFETY**

* If activated on the Configurable Outputs.

7.2.8 SAFETY

The system starts this phase in the following case:

- If the Boiler temperature is more than **A04**

The state is to signal and control the Safety conditions of the system.

| Display Visualization | Combustion Fan | Combustion Fan 2* | Auger | Igniter |
|---|----------------|-------------------|-------|---------|
| Temperature in Boiler alternated to the message MA n and S ic | OFF | OFF | OFF | OFF |

Overcoming the Thermostat **A04**, the functioning Safety starts but the message on the Display is always **Man**. If the Temperature of the Water increases becoming more than Thermostat **A07**, the Display shows **Sic** and activates an acoustic alarm.

End of the state SAFETY:

- If the Boiler temperature is less than **A04** the system turns back to functioning **STANDBY**

* If activated on the Configurable Outputs.

7.2.9 EXTINGUISHING

The system starts this phase in the following cases:

- Through **Button K3** of the Control Board from every State
- For Exhaust Temperature less than Thermostat **F00**
- For the start of some **Alarms**

The state is divided in **2 phases**:

◆ *Extinguishing*

For the EXTINGUISHING of the flame and the disposal of the remaining heat until bringing the Exhaust Temperature under the Thermostat **F00**

| Display Visualization | Combustion Fan | Combustion Fan 2* | Auger | Igniter |
|--|----------------|-------------------|-------|---------|
| Temperature in Boiler alternated to the message SPE . Other Alarm messages | Uc10 | UA10 | OFF | OFF |

◆ *Final Cleaning*

For the final Cleaning of the brazier for a programmable Time as **t89**.

| Display Visualization | Combustion Fan | Combustion Fan 2* | Auger | Igniter |
|--|----------------|-------------------|-------|---------|
| Temperature in Boiler alternated to the message SPE . Other Alarm messages | 99% | 99% | OFF | OFF |

ATTENTION: If the Temperature of the Water in Boiler goes over Thermostat **A03** in both phases, for the security the Combustion Fan and the Combustion Fan 2 are turned off. The fan activates again after the diminishing of the Boiler temperature under the Thermostat.

To bypass the phase of Cleaning set the Value **t09** as **0**.

To bypass the phase of EXTINGUISHING set **P08** as **0**.

End of the state EXTINGUISHING:

- At the end of the phase FINAL CLEANING the system starts functioning **OFF**

* **If activated on the Configurable Outputs.**

7.3 FUNCTIONING COMBI 1

Functioning COMBI 1 is selected with the parameter **P88** = 1, it is described below.

7.3.1 OFF

It is the State Stand-By of the system. It starts at the end of **EXTINGUISHING** of one of the previous functioning. After entering the state the functioning becomes **WOOD**.

| Display Visualization | Combustion Fan | Combustion Fan 2* | Auger | Igniter |
|--|----------------|-------------------|-------|---------|
| Temperature in Boiler alternated to the message OFF . Other Alarm messages | OFF | OFF | OFF | OFF |

If the Exhaust Temperature goes over the Value of the Thermostat **F00** and the parameter **P08** is **1**:

- The system turns to the state **EXTINGUISHING**.

* **If activated on the Configurable Outputs.**

7.3.2 FUNCTIONING SYSTEM WITH WOOD

It starts in the following cases:

- Pushing the **Button K3** of the Control Board from the State of **OFF** or **EXTINGUISHING**

ATTENTION: The Ignition is not allowed with Alarms or Open Door.

After ignited manually the Wood, the system functions as previously described for this type of Combustible. The **Led L6** and **Led L4** are on. With the finishing of the Wood, the decrease of the Exhaust Temperature under the Thermostat **F00**, the system waits for a time Value **t73** then starts **CHECK-UP Functioning with PELLETT**.

7.3.3 SYSTEM FUNCTIONING WITH PELLETT

Finished the Wood combustion, the system turns to Pellet.

7.3.4 RECOVER IGNITION

It starts if there is a **hole** of **Supply**.

| | | |
|-----------------------|------------|--|
| Display Visualization | rEc | Temperature in Boiler alternated to the message rEc |
|-----------------------|------------|--|

The phase has the recover of the state at the moment of the lack of supply according to the sequence:

- **SYSTEM'S ACTUAL STATE ANALYSIS** (length about 5 seconds)
- **If the Functioning was with Pellet before the Ignition of the Wood**
IGNITION with Exhaust thermostat for Pellet
- **If the Functioning was with Pellet soon after the Functioning with Wood**
IGNITION with Exhaust thermostat for Pellet after the Wood
- **If the Functioning was with Pellet at full speed after Functioning with Wood**
IGNITION with Exhaust thermostat for Pellet
- **If the Functioning was with Wood LAST SAVED STATE**

7.4 FUNCTIONING COMBI 2

Functioning COMBI 2 is selected with the parameter **P88** = 2, it is described below.

7.4.1 OFF

It is the Stand-By state of the system. It starts at the end of **EXTINGUISHING** of one of the previous functioning. After entering this state the functioning becomes **WOOD**.

| Display Visualization | Combustion Fan | Combustion Fan 2* | Auger | Igniter |
|--|----------------|-------------------|-------|---------|
| Temperature in Boiler alternated to the message OFF . Other Alarm messages | OFF | OFF | OFF | OFF |

If the Exhaust Temperature goes over the value of the Thermostat **F00** and the parameter **P08** = 1:

➤ The system turns to the **EXTINGUISHING** state.

* **If activated on the Configurable Outputs.**

7.4.2 SYSTEM IGNITION BY PELLET

It starts in the following cases:

➤ Pushing the **Button K3** of the Control Board from the **OFF** or **EXTINGUISHING** states

WARNING: The Ignition is not allowed with Alarms or Door open.

In this phase the System come in **CHECK-UP**, **IGNITION** and **STABILIZATION** with the same mode as described before. During this phases Led **L6** blinks while **L5** is ON.

After completed Pellet ignition, the system goes in Wood Ignition phase 1.

During Pellet Ignition, **F18** and **F21** thermostats will be replaced by **F26** and **F28** thermostats.

7.4.3 WOOD IGNITION

The system will come in this state:

➤ at the end of Ignition/Stabilization of Pellet

Wood Ignition state is composed by 2 phases:

◆ **Phase 1 (Ignition Wood Combustion)**

This phase has got the scope of Ignition of Wood by means Pellet combustion. This phase has got a time duration of **t74**.

During this phase the system works in Pellet mode.

| Display Visualization | Combustion Fan | Combustion Fan 2* | Auger | | | Igniter |
|-----------------------|----------------|-------------------|------------------|----------------|------------------|---------|
| | | | P35 = 0 | P35 = 1 | P35 = 2 | |
| Temperature in Boiler | Uc05 | UA05 | CL05/CP05 | CU05 | CU05 | OFF |
| | | | | | CL05/CP05 | |

End of Phase 1:

➤ If Exhaust temperature is over than **F10** at the end of this phase the system goes in phase 2

➤ If Exhaust temperature is below than **F10** thermostat at the end of this phase the system attempts Pellet Ignition until **P02** times

➤ If numbers of attempts expires the system goes in Extinguishing with **Alt AccF** message on display

➤ If Boiler temperature is over than **A03** thermostat system goes in **STANDBY** in Pellet mode

➤ If Boiler temperature is over **A04** thermostat system goes in **SAFETY** in Pellet mode

NOTE:

- During this phase, if the system goes in **EXTINGUISHING**, Combustion Fan and Combustion Fan 2 will be OFF.
- During this phase if the system goes in **STANDBY** or **SAFETY**, the system will come back to this phase when conditions will be no longer satisfied.

◆ **Phase 2 (Wood Ignition Verify)**

This phase has the scope to verify the Wood Ignition and has got a duration of **t75**.

During this phase the system is in Wood mode.

| Display Visualization | Combustion Fan | Combustion Fan 2* | Auger | Igniter |
|-----------------------|----------------|-------------------|---|---------|
| Temperature in Boiler | Uc05 | UA05 | OFF t30 minutes ON t31 seconds | OFF |

End of phase 2:

- If Exhaust temperature is over than **F10** at the end of this phase the system goes in **NORMAL** in Wood mode
- If Exhaust temperature is below than **F10** thermostat during this phase the system attempts Pellet Ignition until **P02** times
- If numbers of attempts expires the system goes in **EXTINGUISHING** with **ALt AccF** message on display
- If Boiler temperature is over than **A03** thermostat system goes in **STANDBY** in Wood mode
- If Boiler temperature is over **A04** thermostat system goes in **SAFETY** in Wood mode

NOTE:

- During this phase if the system goes in **EXTINGUISHING**, Combustion Fan and Combustion Fan 2 will be OFF.
- During this phase if the system goes in **STANDBY** or **SAFETY**, the system will come back to this phase when conditions will be missing.

7.4.4 RECOVER IGNITION

It starts if there is a **hole** of **Supply**.

| | | |
|-----------------------|------------|--|
| Display Visualization | rEc | Temperature in Boiler alternated to the message rEc |
|-----------------------|------------|--|

The phase has the recover of the state at the moment of the lack of supply according to the sequence:

- **SYSTEM'S ACTUAL STATE ANALYSIS** (length about 5 seconds)
- **If the Functioning was with Pellet before the Ignition of the Wood**
IGNITION with Exhaust thermostat for Pellet
- **If the Functioning was with Pellet soon after the Functioning with Wood**
IGNITION with Exhaust thermostat for Pellet after the Wood
- **If the Functioning was with Pellet at full speed after Functioning with Wood**
IGNITION with Exhaust thermostat for Pellet
- **If the Functioning was with Wood LAST SAVED STATE**

7.4.5 WOOD FUNCTIONING

If Wood is burning, the system works as discussed before (see 7.2.5). This state is signaled by means **L4** and **L6** leds that will be fixed ON. When wood will run out and exhaust temperature goes below **F00** thermostat, after a time of **t73**, the system will change in Pellet mode starting from **CHECK-UP** phase (see 7.4.6).

7.4.6 PELLETT FUNCTIONING

The system works in this mode as discussed in previous chapter (see 0). This phase is signaled by means **L5** and **L6** leds fixed ON.

During **NORMAL** or **MODULATION** states (in Pellet Mode) if the user will load again wood combustible, when and if the exhaust temperature goes over **F29** thermostat the system goes back to Wood Mode (see **Errore. L'origine riferimento non è stata trovata.**).

8 ADDITIONAL FUNCTIONS

8.1 PUMBLING CONFIGURATION MANAGEMENT

The Configuration of the Hydraulic plant connected to the Boiler is very important, because from this depends the functioning of the Pumps, Valves and the Water probes of the system. The selection of the plant type is possible through the parameter **P37**.

8.1.1 PLANT 0

P37 = 0 : Model

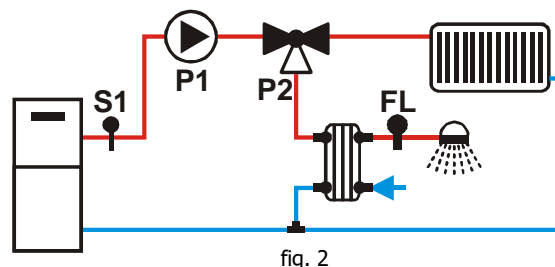
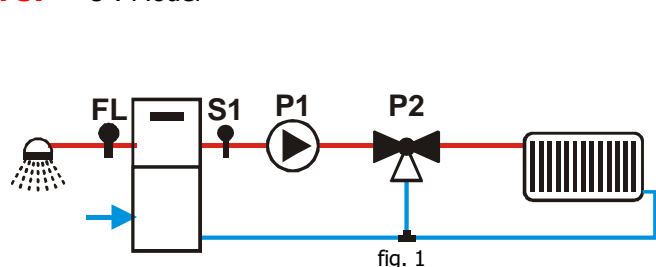

- S1:** Boiler probe
P1: Pump Plant
P2: Diverter valve (Off on heating, ON on Sanitary)
FL: Flowswitch

Functioning

□ Conditions of Safety:

- Boiler temperature less than Thermostat **A00**
- Boiler temperature more than Thermostat **A04**
- Boiler temperature more than Thermostat **A18**
- Input **Rearmed Thermostat of maximum** Open

For each of these conditions the **Pump P1** is always on and the **Valve P2** always off (heating circuit) not depending on the selected Summer/Winter modality.

□ Modality WINTER

Pump P1:

Active over **A17** to make the anti condensation circulation or the production of Sanitary Water.
 Activated over **A01** for the heating, but really activated only with the consent of **Ambient thermostat**.

If deactivated to **Ambient thermostat**, is activated again in case of request of sanitary Water from **Flowswitch**.

Valve P2:

It is normally turned on the Heating circuit.

Overcoming **A17** turns to Circulation/Sanitary.

Overcoming **A01** comes back to the heating system.

It is always on the circuit Circulation/Sanitary for request of sanitary Water from **Flowswitch**.

□ Modality SUMMER

Pump P1:

Active over **A17** to make anti condensation circulation or production of sanitary water.

P78 = 0 : is off over **A01**, if there is no request of Sanitary Water.

P78 = 1 : is always on over **A17**.

Valve P2:

It is always on the circuit Circulation/Sanitary.

Example:

A00 = 5 °C, **A17** = 30 °C, **A01** = 40 °C, **A18** = 80 °C, **A04** = 90 °C

| Temp. PROBE S1 | Flowswitch | Modality | P78 | Valve P2 | Pump P1 |
|-----------------|------------|----------|-----------|-----------|-----------|
| T < 5°C | | | | OFF | ON |
| 5°C ≤ T < 30°C | | | | OFF | OFF |
| 30°C ≤ T < 40°C | | | | ON | ON |
| 40°C ≤ T < 80°C | closed | Winter | | ON | ON |
| | | Summer | | ON | ON |
| | open | Winter | | OFF | ON |
| | | Summer | 0 | ON | OFF |
| | | 1 | ON | ON | |
| T ≥ 80°C | | | | OFF | ON |

8.1.2 PLANT 1

P37 = 1 : Model

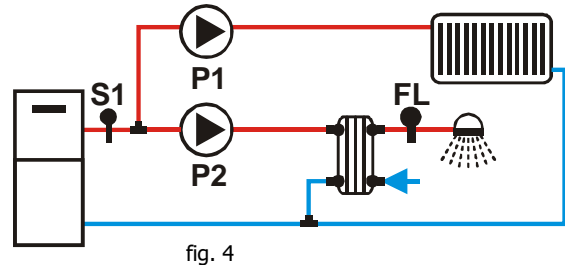
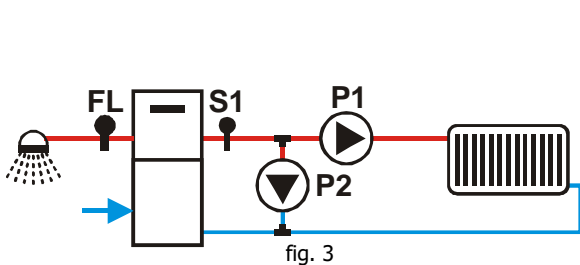

- S1:** Boiler probe
- P1:** Pump Plant
- P2:** Circulation Pump
- FL:** Flowswitch

Functioning

- Safety conditions:**
 - Boiler temperature less than Thermostat **A00**
 - Boiler temperature more than Thermostat **A04**
 - Boiler temperature more than Thermostat **A18**
 - Input **Rearmed thermostat of Maximum** Open

For each condition the **Pump P1** and the **Pump P2** are always on not depending on the selected modality Summer/Winter.
- Modality WINTER**
 - Pump P1:**

Activated over **A01** to make heating, but really activated with the consent of the **Ambient thermostat**.
 In functioning and with request of Sanitary Water from **Flowswitch**, it is disconnected to give priority to the Sanitary.
 - Pump P2:**

It is active over **A17** to make anti condensation circulation or production of sanitary Water.
 It is off over **A01**, if there is no request of Sanitary Water.
- Modality SUMMER**
 - Pump P1:**

It is always OFF
 - Pump P2:**

It is active over **A17** to make anti condensation circulation or production of sanitary Water.
P78 = 0 : is off over **A01**, if there is no request of Sanitary Water.
P78 = 1 : is always on over **A17**.

Example:

A00 = 5 °C, **A17** = 30 °C, **A01** = 40 °C, **A18** = 80 °C, **A04** = 90 °C

| Temp. PROBE S1 | Flowswitch | Modality | P78 | Pump P2 | Pump P1 |
|--|------------|----------|-----------|-----------|-----------|
| $T < 5^{\circ}\text{C}$ | | | | ON | ON |
| $5^{\circ}\text{C} \leq T < 30^{\circ}\text{C}$ | | | | OFF | OFF |
| $30^{\circ}\text{C} \leq T < 40^{\circ}\text{C}$ | | | | ON | OFF |
| $40^{\circ}\text{C} \leq T < 80^{\circ}\text{C}$ | closed | Winter | | ON | OFF |
| | | Summer | | ON | OFF |
| | open | Winter | | OFF | ON |
| | | Summer | 0 | OFF | OFF |
| | | 1 | ON | OFF | |
| $T \geq 80^{\circ}\text{C}$ | | | | ON | ON |

8.1.3 PLANT 2

P37 = 2: Model

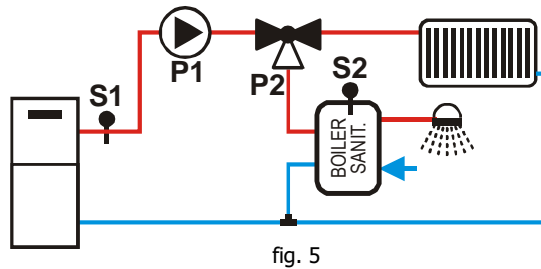

- S1:** Boiler probe
- S2:** Boiler probe
- P1:** Pump Plant
- P2:** Diverter Valve (Off on heating, On on Sanitary)

Functioning

- Safety conditions:**
 - Boiler temperature less than Thermostat **A00**
 - Boiler temperature more than Thermostat **A04**
 - Boiler temperature more than Thermostat **A18**
 - Input **Rearmed thermostat of Maximum** Open

For every condition the **Pump P1** is always on and the **Valve P2** always off (heating circuit) not depending on the selected modality Summer/Winter.
- Modality WINTER**
 - Pump P1:**

It is activated over **A17** to make the Anti condensation circulation or the production of Sanitary Water, but it is really activated if the Boiler temperature is less than **A32** and the Boiler temperature is more than that of the Boiler of **d01** degrees.

It is activated over **A01** to make heating but it is really activated if the Boiler temperature is more than **A32** and after the consent of the **Ambient thermostat**.
 - Valve P2:**

Normally turned on the Heating circuit.

Overcoming **A17**, if the Boiler temperature is less than **A32** turns to the circuit Circulation/Sanitary.

Overcoming **A01**, If the Boiler temperature is more than **A32** turns back to the Heating circuit.
- Modality SUMMER**
 - Pump P1:**

P78 = 0: activated over **A17** to make the Anti condensation circulation or production of Sanitary Water, but really activated if the Boiler temperature is less than **A32** and the Boiler temperature is more than that of the Boiler of **d01** degrees.

P78 = 1: activated over **A17** for fare Anti condensation circulation or the production of Sanitary Water, but really activated if the Boiler temperature is more than that of the Boiler of **d01** degrees.

Valve P2:

Always turned on/Sanitary.

Example:

A00 = 5 °C, **A17** = 30 °C, **A01** = 40 °C, **A32** = 60 °C, **d01** = 5 °C, **A18** = 80 °C, **A04** = 90 °C

| Temp. PROBE S1 | Temp. PROBE S2 | Diff. S1-S2 | Modality | P78 | Valve P2 | Pump P1 | |
|-----------------|----------------|-------------|----------|-----------|-----------|-----------|-----------|
| T < 5°C | | | | | OFF | ON | |
| 5°C ≤ T < 30°C | | | | | OFF | OFF | |
| 30°C ≤ T < 40°C | T < 60°C | < 5°C | | | ON | OFF | |
| | | ≥ 5°C | | | ON | ON | |
| 40°C ≤ T < 80°C | T < 60°C | < 5°C | Winter | | ON | OFF | |
| | | ≥ 5°C | | | ON | ON | |
| | | < 5°C | Summer | | ON | OFF | |
| | | ≥ 5°C | | | ON | ON | |
| | T ≥ 60°C | | Winter | | | OFF | ON |
| | | | Summer | 0 | | ON | OFF |
| | 1 | | | ON | OFF | | |
| | | ≥ 5°C | | | ON | ON | |
| T ≥ 80°C | | | | | OFF | ON | |

8.1.4 PLANT 3

P37 = 3 : Model

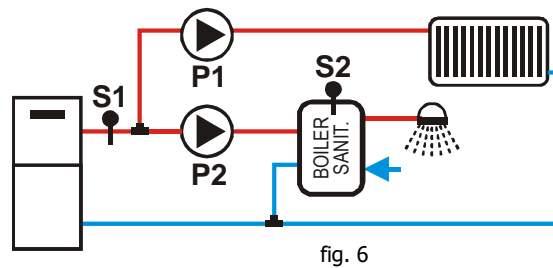

- S1:** Boiler probe
- S2:** Boiler probe
- P1:** Pump Plant
- P2:** Circulation Pump

Functioning

Safety conditions:

Boiler temperature less than Thermostat **A00**
 Boiler temperature more than Thermostat **A04**
 Boiler temperature more than Thermostat **A18**
 Input **Rearmed thermostat of Maximum** Open

For every condition the **Pump P1** and the **Pump P2** are always active not depending on the selected modality Summer/Winter.

Modality WINTER

Pump P1:

Activated over **A01** to make Heating, but really activated if the Boiler temperature is more than **A32** and after consent of the **Ambient thermostat**.

Pump P2:

Activated over **A17** to make Anti condensation circulation or production of Sanitary Water, but really activated if the Boiler temperature is less than **A32** and the Boiler temperature is more than that of the boiler of **d01** degrees.

It is off over **A01**, if there is no request of Sanitary Water.

Modality SUMMER

Pump P1:

Always off

Pump P2:

P78 = 0: Activated over **A17** to make Anti condensation circulation or the production of Sanitary Water, but really activated if the Boiler temperature is less than **A32** and the Boiler temperature is more than that of the Boiler of **d01** degrees.

P78 = 1, Activated over **A17** to make Anti condensation circulation or the production of Sanitary Water, but really activated if the Boiler temperature is more than that of the Boiler of **d01** degrees.

Example:

A00 = 5 °C, A17 = 30 °C, A01 = 40 °C, A32 = 60 °C, d01 = 5 °C, A18 = 80 °C, A04 = 90 °C

| Temp. PROBE S1 | Temp. PROBE S2 | Diff. S1-S2 | Modality | P78 | Pump P2 | Pump P1 | |
|-----------------|----------------|-------------|----------|-----------|-----------|-----------|-----------|
| T < 5°C | | | | | ON | ON | |
| 5°C ≤ T < 30°C | | | | | OFF | OFF | |
| 30°C ≤ T < 40°C | T < 60°C | < 5°C | | | OFF | OFF | |
| | | ≥ 5°C | | | ON | OFF | |
| 40°C ≤ T < 80°C | T < 60°C | < 5°C | Winter | | OFF | OFF | |
| | | ≥ 5°C | | | ON | OFF | |
| | | < 5°C | Summer | | OFF | OFF | |
| | ≥ 5°C | | | ON | OFF | | |
| | T ≥ 60°C | | | Winter | | OFF | ON |
| | | | | Summer | 0 | OFF | OFF |
| | | | 1 | | OFF | OFF | |
| | | < 5°C | | | ON | OFF | |
| | | ≥ 5°C | | | ON | OFF | |
| T ≥ 80°C | | | | | ON | ON | |

8.1.5 PLANT 4

P37 = 4: Model

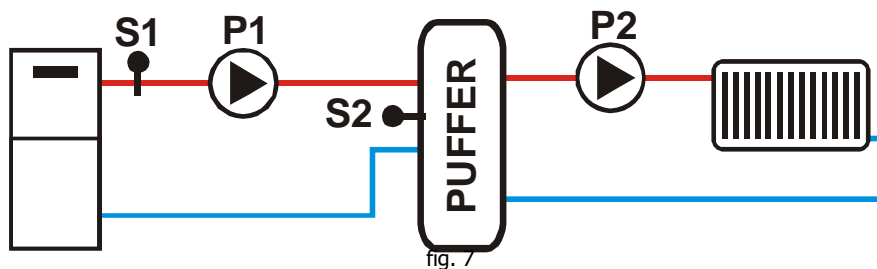

- S1:** Boiler probe
- S2:** Boiler probe
- P1:** Pump Puffer loading
- P2:** Pump Plant

Functioning

Safety conditions:

- Boiler temperature less than Thermostat **A00**
- Boiler temperature more than Thermostat **A04**
- Boiler temperature more than Thermostat **A18**
- Input **Rearmed thermostat of Maximum** Open

For each conditions the **Pump P1** and the **Pump P2** are always active not depending to the selected modality Summer/Winter.

Modality WINTER

Pump P1:

Activated over **A01** to make the Puffer loading, but really activated if the Boiler temperature is more than that of the Puffer of **d01** degrees.

Pump P2:

Activated over **A34** to make Heating, but really activated after consent of the **Ambient thermostat**.

Modality SUMMER

Pump P1:

Activated over **A01** to make the Puffer loading, but really activated if the Boiler temperature is more than that of the Puffer of **d01** degrees.

Pump P2:
Always off

Example:

A00 = 5 °C, **A01** = 40 °C, **A34** = 50 °C, **d01** = 5 °C, **A18** = 80 °C, **A04** = 90 °C

| Temp. PROBE S1 | Diff. S1-S2 | Pump P1 | | Temp. PROBE S2 | Modality | Pump P2 |
|-----------------|-------------|-----------|--|----------------|----------|-----------|
| T < 5°C | | ON | | | | ON |
| 5°C ≤ T < 40°C | | OFF | | T < 50°C | | OFF |
| 40°C ≤ T < 80°C | < 5°C | OFF | | T ≥ 50°C | Winter | ON |
| | ≥ 5°C | ON | | | Summer | OFF |
| T ≥ 80°C | | ON | | | | ON |

8.1.6 PLANT 5

P37 = 5: Model

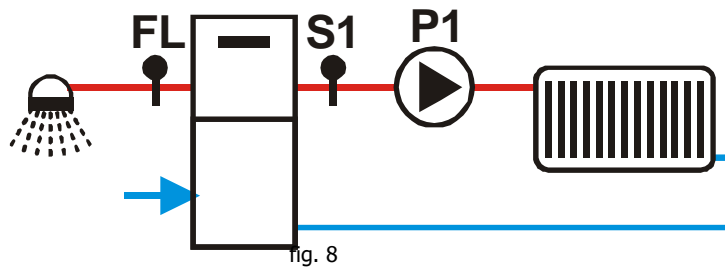

- S1:** Boiler probe
- P1:** Pump Plant
- P2:** Output under Thermostat Boiler probe (not in the hydraulic model)
- FL:** Flowswitch

Functioning

- Safety conditions:**
 - Boiler temperature less than Thermostat **A00**
 - Boiler temperature more than Thermostat **A04**
 - Boiler temperature more than Thermostat **A18**
 - Input **Rearmed thermostat of Maximum** Open

For each conditions the **Pump P1** is always active not depending to the selected modality Summer/Winter.
- Modality WINTER**

Pump P1:
Activated over **A01** to make Heating, but really activated after the consent f the **Ambient thermostat**.
If functioning and with request of Sanitary Water from **Flowswitch**, it is deactivated to give priority to the Sanitary.
- Modality SUMMER**

Pump P1:
Always off

Output Thermostat P2:

Active if the Boiler temperature is over **A17**

Example:

A00 = 5 °C, **A17** = 50 °C, **A01** = 40 °C, **A18** = 80 °C, **A04** = 90 °C

| Temp. PROBE S1 | Flowswitch | Modality | Pump P1 |
|-----------------|------------|----------|-----------|
| T < 5°C | | | ON |
| 5°C ≤ T < 40°C | | | OFF |
| 40°C ≤ T < 80°C | closed | Winter | OFF |
| | | Summer | OFF |
| | open | Winter | ON |
| | | Summer | OFF |
| T ≥ 80°C | | | ON |

| Temp. PROBE S1 | Output P2 |
|----------------|-----------|
| T < 50°C | OFF |
| T ≥ 50°C | ON |

8.1.7 PLANT 6

P37 = 6 : Model

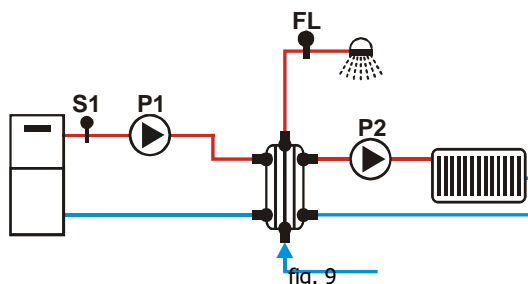

- S1:** Boiler probe
- P1:** Circulation Pump
- P2:** Pump Plant
- FL:** Flowswitch

Functioning

Safety conditions:

- Boiler temperature less than Thermostat **A00**
- Boiler temperature more than Thermostat **A04**
- Boiler temperature more than Thermostat **A18**
- Input **Rearmed thermostat of Maximum** Open

For each conditions the **Pump P1** and the **Pump P2** are always active not depending to the selected modality Summer/Winter.

Modality WINTER

Pump P1:

It is active over **A17** to make Anti condensation circulation or the production of Sanitary Water.

Pump P2:

Activated over **A01** to make Heating, but really activated only after consent of **Ambient thermostat**.

If functioning and with request of Sanitary Water from **Flowswitch**, it is deactivated to give priority to the Sanitary.

Modality SUMMER

Pump P1:

It is active over **A17** to make Anti condensation circulation or the production of Sanitary Water.

Pump P2:

Always off

Example:

A00 = 5 °C, **A17** = 30 °C, **A01** = 40 °C, **A18** = 80 °C, **A04** = 90 °C

| Temp. PROBE S1 | Flowswitch | Modality | Pump P2 | Pump P1 |
|-----------------|------------|----------|-----------|-----------|
| T < 5°C | | | ON | ON |
| 5°C ≤ T < 30°C | | | OFF | OFF |
| 30°C ≤ T < 40°C | | | ON | OFF |
| 40°C ≤ T < 80°C | closed | Winter | ON | OFF |
| | | Summer | ON | OFF |
| | open | Winter | ON | ON |
| | | Summer | ON | OFF |
| T ≥ 80°C | | | ON | ON |
| | | | | |

8.2 SYSTEM'S FUNCTIONING MODALITY

The user has the possibility to chose the functioning modality among three. The selection is possible pushing for long the **Button K4** during the state **OFF**. The choice appears on the Control Board, through the LED Ignition:

| Functioning System[P44] | Led | DESCRIPTION |
|-------------------------|-------------------|---|
| 0 | Led Wood | Functioning only with Wood |
| 1 | Led Pellet | Functioning only with Chopped combustible |
| 2 | Led Combi | Functioning with Wood start, until finishing, than change to chopped |

8.3 CONFIGURABLE OUTPUTS MANAGEMENT

It is possible to configure the outputs OUT2 (pin 5-6), OUT4 (11-12) and OUT AUX (39-40) according to the value of the connected managing Parameters (**P59**, **P60** e **P61**). The possible configurations are in the table:

| Value Parameter | Output Type | Output | | |
|-----------------|----------------------------------|---------------------|---------------------|------------------------|
| | | OUT2 (P59) | OUT4 (P60) | OUT AUX (P61) |
| 0 | Output Deactivated | √ | √ | √ |
| 1 | Valve Safety (See Ch. 8.3.1) | √ | √ | √ |
| 2 | Loading Engine (See Ch. 0) | √ | √ | √ |
| 4 | Cleaning Engine (See Ch. 0) | √ | √ | √ |
| 5 | Combustion Fan 2 (See Ch. 0) | √ | × | × |
| 7 | Air Valve (See Ch. 0) | √ | √ | √ |
| 8 | Auger with Relay (See Ch. ·) | × | √ | × |
| 9 | Inverter consent (See Ch. 8.3.7) | × | × | √ |
| 11 | Error warning (See Ch 0) | √ | √ | √ |
| 16 | Auger 2 Pause Work (See Ch. 0) | √ | √ | × |
| 17 | Auger 2 always on (See Ch. 0) | √ | √ | × |
| 28 | Valve Safety 2 (See Ch.0) | √ | √ | √ |

Not available functions: 3-6-10-12-13-14-15-18-19-20-21-22-23-24-25-26-27

√ = Function implemented

× = Function not implemented (Output deactivates)

Setting an output as not available function it's how to set it as Disabled

NOTE:

The Output OUT AUX is with clean contact; if it is used to manage an air valve aria supply as in the figure

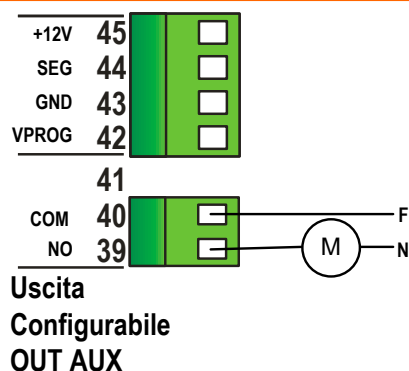

Output OUT AUX Supplied

8.3.1 SAFETY VALVE

The Output is active when the Auger is activated: the Auger activates only after the timer **t72**. About the behavior in case of Pellet Thermostat Alarm see Ch. 3.2.

| <i>System State</i> | <i>Safety Valve</i> |
|---|---|
| Check Up | On (if t72 > 0) Off (if t72 = 0) |
| Ignition, Stabilization, Normal, Modulation, Maintenance (phase Work) | On (if t72 > 0) Off (if t72 = 0) |
| Maintenance (phase Pause) | On if t72 > t04 or t72 seconds before the end of t04 if t72 ≤ t04 |
| Safety | Off |
| Other states | Off |

Nota:

The phase 1 of the Ignition starts after **t72**.

8.3.2 PELLET LOADING ENGINE

When the Pellet Level Sensor signals the absence of material, the Output to load the tank activates. If in the Time **t55** the Pellets reaches the set level, the system starts EXTINGUISHING and on the display the message of Error **Alt Pell**. If the tank is manually loaded, it is possible to reset the Error and ignite again the system. If on the contrary the pellet's level is reached, the loading of the material goes on for a Time **t56**.

8.3.3 CLEANING ENGINE

The Output is active for a Time **t25** seconds when the system reaches the number of functioning minutes Normal and Modulation equal to **t24**.

8.3.4 COMBUSTION FAN 2

The Output is managed as described in the functioning states.

8.3.5 AIR VALVE

The Output is active if the Comburent Fan is ON based on **P82** settings:

- **P82** = 0 Active in Wood and Pellet Mode
- **P82** = 1 Active only in Pellet Mode
- **P82** = 2 Active only in Wood Mode
-

8.3.6 AUGER WITH RELAY

The Output is managed as described in the functioning states with the difference that there is the Relay Output not Triac.

8.3.7 INVERTER CONSENT

The Output is for the control of the inverter consent for the Auger and runs in the following ways:

- if **P35** = 0 Output is always active in case of Auger activated to the functioning (both with Time ON and OFF)
- if **P35** = 1 Output is active if the programming speed of the inverter is more than zero
- if **P35** = 2 Output is active if the programming speed of the inverter is more than zero and in Time ON interval

8.3.8 ERROR WARNING

The Output is active if an error is present.

8.3.9 AUGER 2 PAUSE WORK

Auger 2 is on for an increased time, compared to that of the Auger 1, of a percentage **P72**. the maximum work time is the Auger Period 1. In Extinguishing and Standby, during the Pellet functioning, the output turns off only when the timer **t90** expires. About the behavior in case of Pellet Thermostat Alarm see Ch. 3.2.

8.3.10 AUGER 2 ALWAYS ON

The output is active when the Auger is activated: the Auger 2 deactivates respect to the Auger, after the timer **t90**. The Auger2 does not work in Pause/Work. About the behavior in case of Pellet Thermostat Alarm see Ch. 3.2.

| <i>System State</i> | <i>Auger2</i> |
|---|---------------|
| Check Up | Off |
| Ignition, Stabilization, Normal, Modulation, Maintenance (phase Work) | On |
| Maintenance (phase Pause) | Off |
| Safety | Off |
| Other states | Off |

8.3.11 SAFETY VALVE 2

Safety Valve 2 follows the behavior described in Ch. 8.3.1, except when there is Pellet Thermostat Alarm on (see Ch. 3.2).

8.4 AUGER WITH WOOD PROGRESS

In all cases, during the functioning with Wood, the Pellet in the carrying system burns, it is possible to use the progress function of the Auger to maintain the channel Pellet always full.

For this reason, the Auger activates for a time **t31** seconds every **t30** minutes. If one of the configurable outputs is set as Safety Valve, the system waits its opening (for a Time **t72**) before activating the Auger. If the pellet level in the tank goes under the probe, there is the signal on the display **PELL**.

The signal remains in case of engine loading not present and also in the other case if within **t55** seconds the pellet level is not right. In this case there is also the interruption of the Auger progress and the Closing of the Safety Valve. To deactivate the function set **t31** = 0.

8.5 INVERTER MANAGEMENT

The control board is capable to manage Three-phase or Mono-phase motors for the Auger and for the Combustion Fans. The configuration is managed by parameter **P35**.

P35 = 0

- Inverter management disabled. Connect the motors as follows: Auger pin 9-10, Combustion Fan pin 3-4 and Combustion Fan 2 pin5-6.

P35 = 1 – Inverter for Auger in continuous mode

- Connect the Inverter power supply to pin 9-10, the programming to pin 42-43 and the consent to pin 39-40.
- The auger speed regulation is performed via parameters identified as **CUxx**
- The auger is enabled if the programming speed of the Inverter is major than 0.

P35 = 2 – Inverter for Auger in Pause/Work mode

- Connect the Inverter power supply to pin 9-10, the programming to pin 42-43 and the consent to pin 39-40.
- The auger speed regulation is performed via parameters identified as **CUxx**
- The auger is enabled if the programming speed of the Inverter is major than 0 and the range is inside the parameters **CLxx** and **CPxx**.

P35 = 3 - Inverter for Combustion Fan

- Connect the Inverter power supply externally, the programming to pin 42-43 and shortcircuit the consent.
- The combustion fan speed regulation is performed via parameters identified as **UCxx**
- The functioning is the same described during the standard phase work of the system

P35 = 4 - Inverter for Combustion Fan 2

- Connect the Inverter power supply externally, the programming to pin 42-43 and shortcircuit the consent.
- The combustion fan speed regulation is performed via parameters identified as **UAxx**
- The functioning is the same described during the standard phase work of the system

8.6 MODEM GSM MANAGEMENT

The controller can manage a **Modem GSM** (provided if requested).

The Modem must be connected with the provided cable, to the **RS232** of the Controller.

For the detail about the Modem connection and the cables to use, see the appendix of the Software manual **SYSTEM EVOLUTION**.

To activate the Modem functioning, set the parameter **P90 = 1**.

The modem must be provided of a SIM of any provider, that the owner of the Boiler must buy.

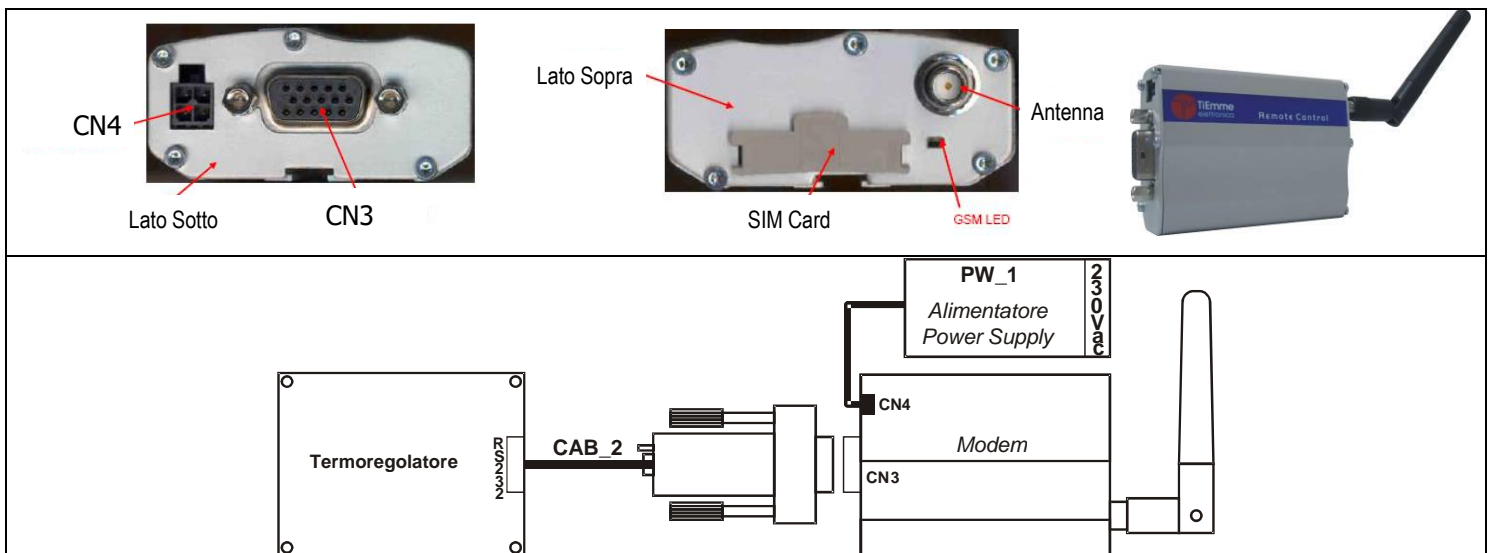

Before inserting the SIM in the Modem, remove the supply.

ATTENTION: deactivate the PIN of the SIM, before putting it in the modem.

After inserting the SIM and supplied the Modem, verify its State controlling the blinking of the Led under the aerial.

The signals are the following:

| LED GSM | LED Activity | Modem State |
|-----------|--------------|--------------------------------|
| ON | LED On fixed | The modem is On and ready but: |

| | | |
|------------|--------------------------------|--|
| | | _ Not registered to the net _ The SIM has a PIN request active or it is not inserted _ the aerial is not connected or there is no signal |
| | LED blinking (every 2 seconds) | Modem On and ready to make or receive calls |
| OFF | LED OFF | Modem not supplied or in phase of Reset |

8.6.1 BASIC FUNCTION

This function uses a Modem to control the system at distance through an SMS:

- Control Ignition / EXTINGUISHING of the system
- Request the functioning State and the errors

For this functioning modality the SIM of the Modem can be Normal, activated only for the voice traffic.

The user must send an SMS to the SIM Card number that is in the Modem, with one of these key words:

- **START**
- **STOP**
- **STATUS**
- **RESET**
- **LEARN**

Uppercase or lowercase...

The message **START** ignites the Boiler (if not already on). The control board answers to the calling number with a message that indicates: The Boiler state, Temperature of the Water and the possible **Error**.

The message **STOP** extinguishes the Boiler (if not already off). The control board answers to the calling number with a message that indicates: The Boiler state, Temperature of the Water and the possible **Error**.

The message **STATUS** requests the state of the Boiler. The control board answers to the calling number with a message that indicates: The Boiler state, Temperature of the Water and the possible **Error**.

The message **RESET** deletes (if possible) the error that led to the Extinguishing of the system. The control board answers to the calling number with a message that indicates: The Boiler state, Temperature of the Water and the possible **Error**

The message **LEARN** saves on the controller the mobile number to which send the SMS, in case the Boiler turns off for Errors (the answer to the message is **OK**). The controller in this situation send automatically an SMS with the Boiler state, the water temperature and the error that has turned it off.

Example of messages sent by control board:

ON – Nor. 50°C

Message without errors that indicates: Boiler on (**ON**), State Normal (**Nor.**), with Water Temperature 50 degrees (**50°C**).

OFF – Spe. 105°C. tSic

Message with errors that indicates: Boiler in EXTINGUISHING (**OFF**), in the State EXTINGUISHING (**Spe.**), with Water Temperature 105 degrees (**105°C**), for Error Intervention Rearmed thermostat(**tSic**).

The abbreviations used to indicate the errors are the same that appear on the controller's Display plus **Nor**, to indicate the State Normal.

8.6.2 ADVANCED FUNCTION

This Function uses a Modem to control the system at a distance

This is possible with the use of a Software **SYSTEM EVOLUTION**.

See the Software manual, for the instructions.

ATTENTION: for this modality it is necessary that the SIM of the Modem are activated to the GSM data traffic not only voice.

8.7 COMMUNICATION RS232

The controller is provided for the communication **RS232** with a Computer. Connecting the controller to a serial Port and launching the Program **SYSTEM EVOLUTION**, it is possible to control the controller's functioning and do the program of all Parameters.

To know the functioning of the **SYSTEM EVOLUTION** and how to connect the Controller to the PC, see the Software manual that is in the Computer, if you have already installed the program.

8.8 FIRMWARE UPDATE

The update of the Controller's firmware and how to connect it to the different programmers is in the Software manual that is in the Computer, if you have already installed the program **SYSTEM EVOLUTION**.

8.9 DIAGNOSTIC FUNCTION

In this paragraph there are the instructions for the diagnosing of the hardware of the control board and in particular the control of the outputs and inputs. Inputs and outputs can be analogical or digital.

For this reason there are 2 procedures:

1. To check the analogical inputs, in State **OFF**, verify the correct reading of the probes connected, in the following way:

- **Boiler probe** Always Visible from Display
- **Exhaust probe** entering the user menu
- **Boiler probe*** entering the user menu
- **Photoresistance*** entering the user menu

*only if provided by the parameter

2. To check the digital inputs and outputs is possible to use the self test modality of the board pushing, in State **OFF**, together for 5 seconds **Button K1** and **K4**. In the modality, the visualisation, the outputs and the inputs of the controller do not follow the described functioning but appears **tEst** and all leds are on.

a) Inputs test:

The input check is a function that helps to find the causes of failures, malfunctioning or the correct electrical connections connected to the control system and to the heating systems connected. Do as follows:

- Enter pushing **Button K1**.
- The controller shows on the Display the name of the first Input. The abbreviations can be the same:

| Name | TYPE | DESCRIPTION | Visible | Validation Time State change [s] |
|-------------|------------------------------------|---------------------------------------|------------------------------|-------------------------------------|
| In01 | Normally closed | Air Pressure Switch/Pellet Thermostat | Only if P91 = 1,2 | 3 |
| In02 | Normally closed | Ambient thermostat | Always | 3 |
| In03 | Normally closed | Door | Always | 1 |
| In04 | Normally closed | Chrono | Always | 3 |
| In06 | Normally open | Flowswitch | Only systems with Flowswitch | 3 |
| In07 | Normally open | Grid sensor/Pellet Thermostat* | Only if P27 = 1,4 | 3 |
| In09 | Normally closed | Rearmed thermostat of Maximum | Always | 3 |
| In10 | Second Configuration P54 | Pellet Level | Always | 5 |

- With **Button K1** select the Input to test.
- According to the selected input Time there are the following conditions:

- Input Normally closed if bridged -> display indication **OFF**
 - Input Normally closed if open (not bridged) -> display indication **ON**
 - Input Normally open if bridged -> display indication **ON**
 - Input Normally open if not bridged -> display indication **OFF**
 - The change ON/OFF has a delay as Time validation in table
- NOTA:** the Input Rearmed thermostat of Maximum is in High tension. PAY ATTENTION.

*In case of Pellet Thermostat the contact is to be considered as N.C.

b) **Outputs Test:**

- At the bottom of input test, pushing again **Button K1**, enter the outputs test
- The controller test the first Output using the name on the Display. The abbreviations that can appear are:

| Num. | Nome | TYPE | DESCRIPTION |
|------|-------------|--------------------------|----------------|
| 1 | Ou01 | Speed regulation | Combustion Fan |
| 2 | Ou02 | Speed regulation /ON OFF | Output OUT2 |
| 3 | Ou03 | Speed regulation /ON OFF | Auger |
| 4 | Ou04 | ON/OFF Supplied | Output OUT4 |
| 5 | Ou05 | ON/OFF Supplied | Igniter |
| 6 | Ou06 | ON/OFF Supplied | Pump |
| 7 | Ou07 | ON/OFF Supplied | Valve/Pump2 |
| 8 | Ou08 | ON/OFF | Output OUT AUX |

- Pushing again **Button K1** it is possible to slide the outputs.
- Testing the Outputs with **Regulation of the speed**, on the Display is alternated the name of the tested Output and the speed, that initially is **0% OFF**.
- With **Buttons K2** and **K3**, it is possible to increase or decrease the speed with steps of 1% (pushing the buttons for 2 seconds the sling of the digit is automatic).
- Testing the Outputs **ON/OFF**, on the Display is alternated the name of the tested Output sotto test and the current state that initially is **OFF OFF**.
- With **Button K3** it is possible to **ignite** the Output and on the Display **OFF** is substituted by **ON**.
- With **Button K2** It is possible to extinguish again the output.
- To change the Output is not needed that are OFF. After having sliding all with **Button K1**, the controller automatically turns them off and comes back to the initial visualisation with **tEst**.

NOTE:

- If making the test Output **Auger**, this remains off but on the display there is **ON**, verify the Input of the **Rearmed thermostat of Maximum** is closed. This stops the supply to the Output from the voltage. The exit from the functioning of **Self Test** could be with:

- Pushing **Button K4** of the Control Board.
- Expiring Maximum staying Time that is **60 seconds**, if not pushed any Button.
- Safety if the Temperature of the Water is higher than Thermostat **A03**.

After the exit it comes back to the State **OFF**.